

Subsidy Project of Decommissioning and Contaminated Water Management for FY2021

Development of Fuel Debris Retrieval Method (Development of Isolation Technology to Prevent the Spread of Contamination during Retrieval and Transportation of Large Structures)

Accomplishment Report for FY2021

August 2022

International Research Institute for Nuclear Decommissioning
(IRID)

Table of Contents

1. Purpose and Goals of “Development of Fuel Debris Retrieval Method (Development of isolation technology to prevent the spread of contamination during removal and transportation of large structures)”
2. Results and Contents of the Study on Top Access Method Conducted as Part of Subsidy Projects
3. Project Overview
4. Implementation Schedule
5. Project Organization
6. Implementation Items of This Project
7. Summary
8. Specific Goals for Achieving the Purpose of the Project

1. Purpose and Goals of “Development of Fuel Debris Retrieval Method

(Development of isolation technology to prevent the spread of contamination during removal and transportation of large structures)”

[Purpose of development of fuel debris retrieval method]

It is assumed that nuclear fuel has melted along with the internal structures) and exists as fuel debris in the Reactor Pressure Vessel (RPV) and the Primary Containment Vessel (PCV) at Tokyo Electric Power Company Holdings, Inc. (TEPCO) Fukushima Daiichi Nuclear Power Station (1F).

Assuming that the fuel debris present inside the RPV and PCV is currently in a sub-critical state, however, the plant itself is in an unstable condition unlike its initial design since the Reactor Building (R/B), RPV and PCV, etc. have been damaged due to the accident. For this reason, the fuel debris should be retrieved and maintained under a stable condition to prevent the spread of radioactive materials.

Against this background, this project aims to study on the implementation of fuel debris retrieval on a further increased scale in coordination with the engineering and project management activities undertaken by TEPCO in accordance with the “Mid-and-Long-term Road-map Towards Decommissioning of TEPCO’s Fukushima Daiichi Nuclear Power Station” (hereinafter “Mid-and-Long-Term Road-map”). The development results of this project will be used in TEPCO’s engineering activities.

The purpose of this project is to smoothly carry out decommissioning and contaminated water management at 1F by implementing projects that support technological development contributing to the decommissioning and contaminated water management at 1F based on the Mid-and-Long-Term Road-map and the “FY2021 Decommissioning Research & Development Plan” (Secretariat Team Meeting for Countermeasures for Decommissioning and Contaminated Water Treatment (86th), and in addition, to make efforts to enhance the standard of science and technology in Japan.

As part of “Development of Isolation Technology to Prevent the Spread of Contamination during Retrieval and Transportation of Large Structures”, elemental technologies related to confinement of radioactive materials, which is essential to ensure the safety of the public and workers during removal and transportation of large structures, and related to isolation for reducing the radiation exposure of the workers, will be developed for further increasing the scale of retrieval of fuel debris and internal structures.

[Project goal]

The goal of the project is to study the implementation of fuel debris retrieval on a further increasing scale based on the Mid-and-Long-Term Road-map.

[Duration of Project] December 2021 to March 2023 (16 months)

2. Results and Contents of the Study on Top Access Method Conducted as Part of Subsidy Projects

The results of **past subsidy** projects and the contents of studies in the ongoing subsidy projects were examined.

(1) Results of past subsidy projects related to the top access method

[Main results of studies conducted as part of Upgrading of Fundamental Technology for Retrieval of Fuel Debris and Internal Structures (hereinafter "Fundamental Technology Upgrade": implemented in FY2017-18)]

- An image of constructing the access route (removal of interfering objects) was created and elemental tests were conducted using structural simulations of the reactor bottom to verify the feasibility of the removal procedure.
- The retrieval duration (throughput) was estimated by assuming details of the procedure such as the unit to be cut out, the shape and thickness of the portion to be cut, and the cutting method, etc.

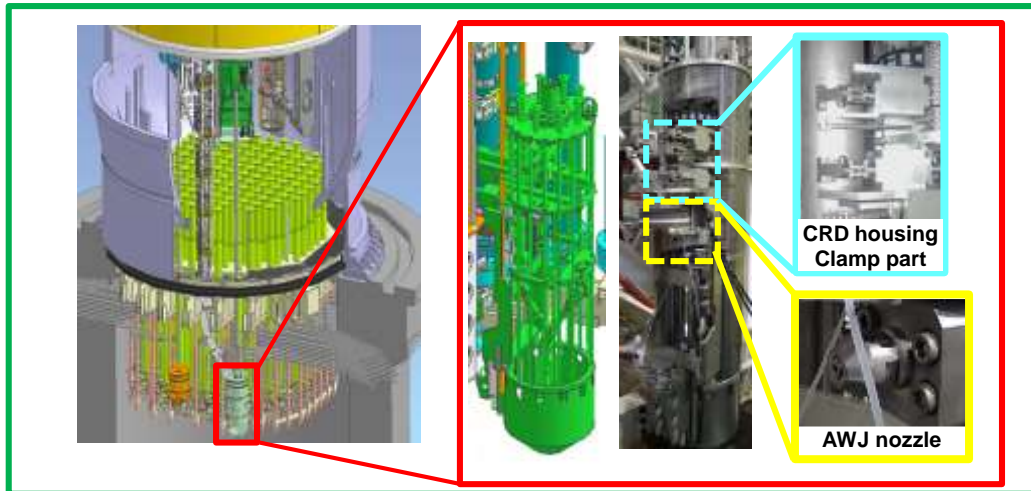

Removal of large structures from the reactor bottom

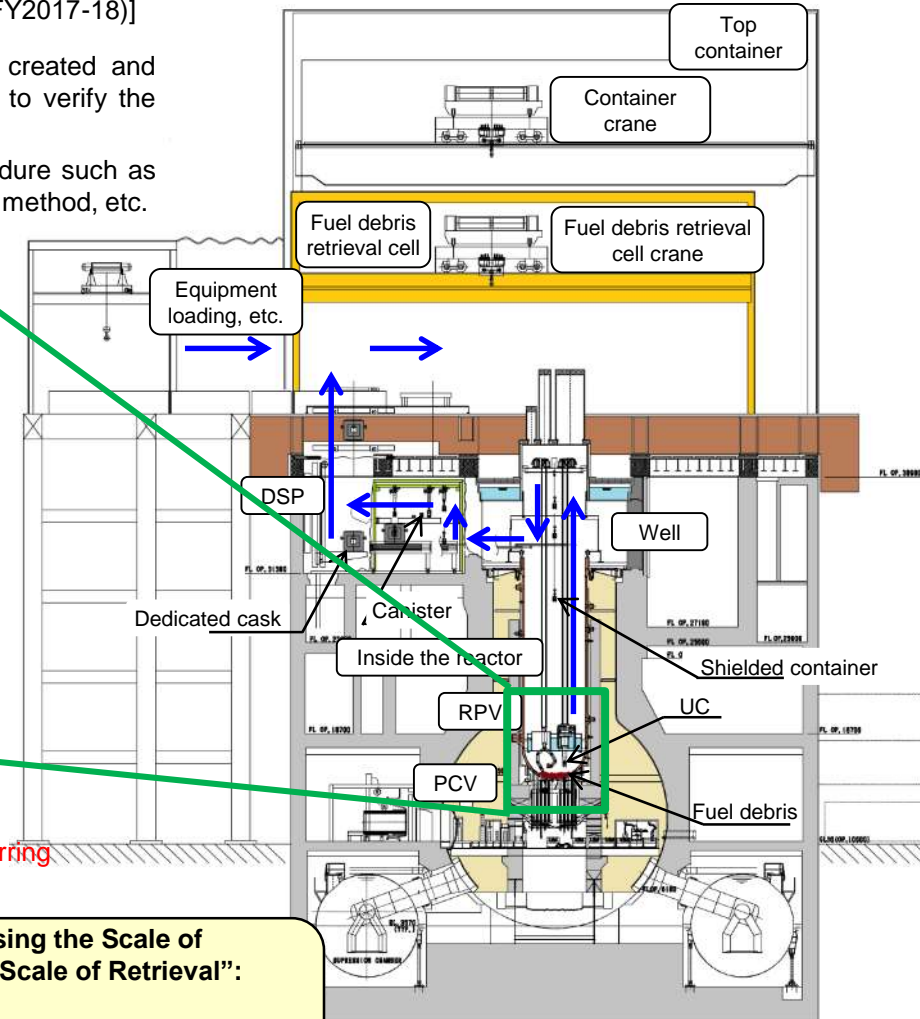

The Method for cutting the structures inside the PCV, collecting them in unit cans and transferring them **is quite challenging in terms of work efficiency and time required for work.**

[Implementation details pertaining to Development of Technology for Further Increasing the Scale of Retrieval of Fuel Debris and Internal Structures (hereinafter, "Further Increasing the Scale of Retrieval": implemented in FY2019-20)]

Verifying the feasibility of **the method for transferring the structure as large as possible and then cutting them in a separate building.**

2. Results and Contents of the Study on Top Access Method Conducted as Part of Subsidy Projects

(1) Results of past subsidy projects related to the top access method

[Concepts of the new top access method (removing and transferring the unitized structure)]

The concept of the method for removing and transferring the unitized structure, which was studied under “Further Increasing the Scale of Retrieval”, is indicated below.

- ✓ Individual structures are transferred as the unitized structure
- ✓ The reactor core is cut into multiple units, and the lower hemispherical dome of the reactor bottom is separated in its entirety from the RPV.
- ✓ The shielding and air-tightness of the objects to be transferred is ensured by means of a container or access route or a combination of both.
- ✓ The work of finely cutting the structures that are retrieved and collecting them in a container is carried out in a building that is at a distance from the R/B.

[Items studied under project of “Development of Technology for Further Increasing the Retrieval Scale of Fuel Debris”]

The following items was studied in the FY2019-20 Subsidy Project (Development of Technology for Further Increasing the Retrieval Scale of Fuel Debris).

- ✓ Study of method for transferring (transfer route) the unitized structure.
- ✓ Study of the method for disassembling the reactor bottom and related elemental tests

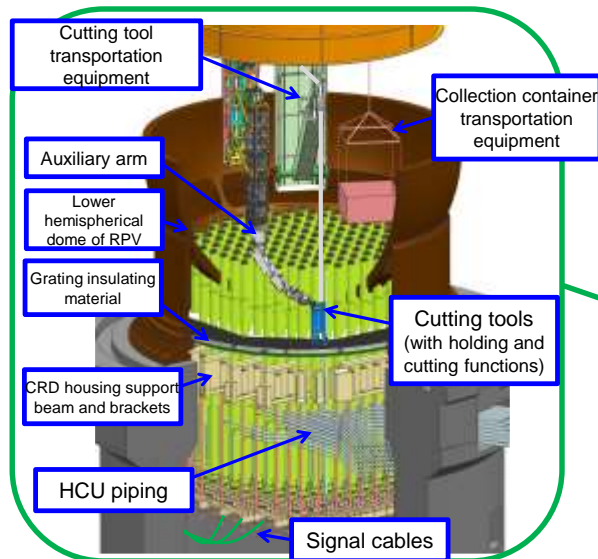
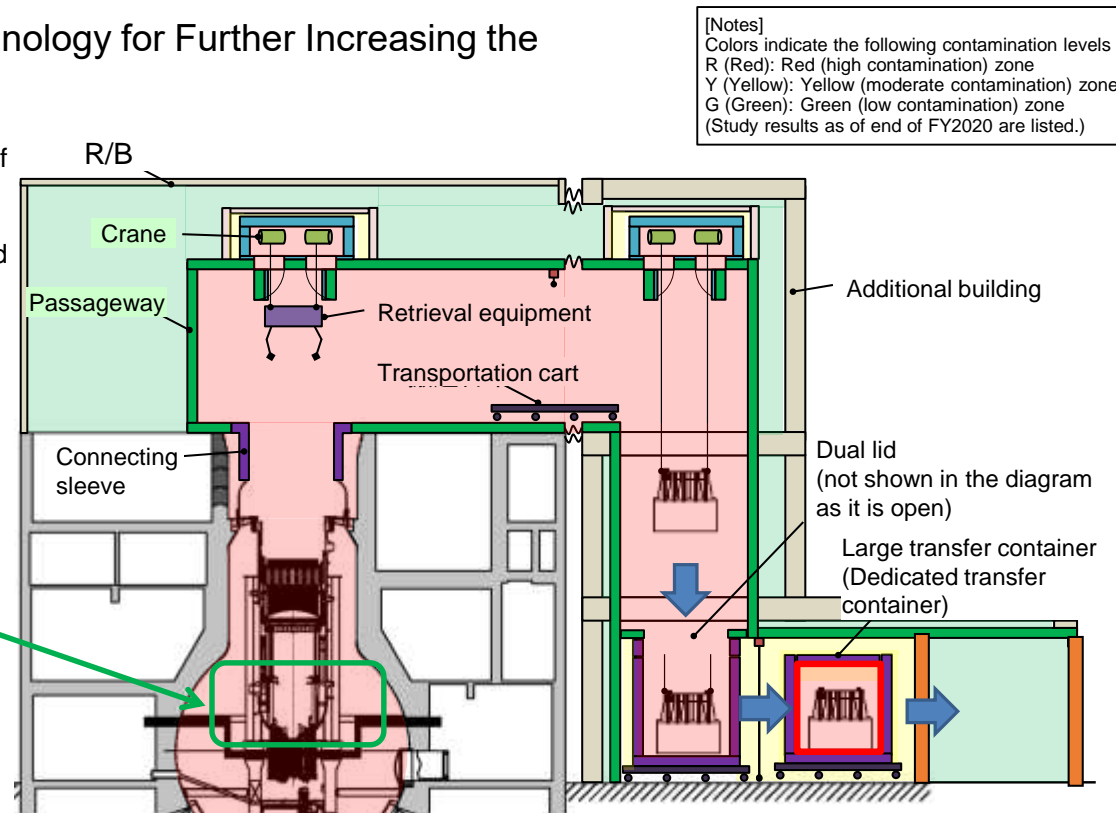

Illustration of reactor bottom interference objects removal work



Method for transferring (transfer route) the unitized structure under consideration

2. Results and Contents of the Study on Top Access Method Conducted as Part of Subsidy Projects

(2) Contents of studies conducted under the Project for "Development of Fuel Debris Retrieval Method" (hereinafter, "Retrieval Method: ongoing in FY2021-22)

Technological development of [1] Method for cutting large structures, [2] Large transfer containers, and [3] Large transportation equipment for the top access method is underway.

[1] Method for cutting large structures

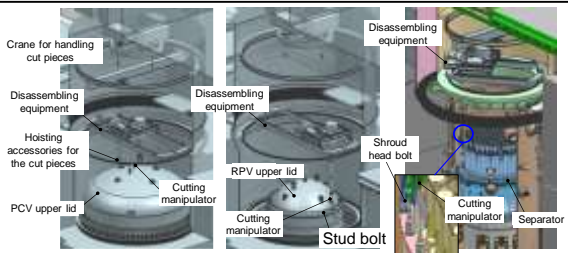

Conceptual study is conducted on further increasing the scale of retrieval (implemented in FY2019- 20)

Method for cutting structures other than internal structures

Method for cutting internal structures

Illustration of filling and cutting

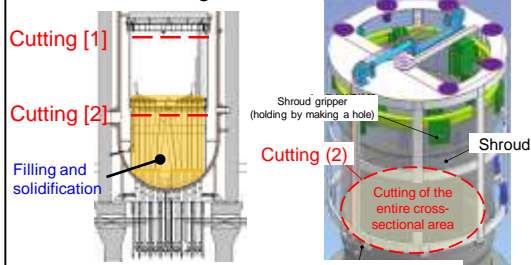

Elemental tests are conducted on further increasing the scale of retrieval (FY2019- 20)

The Method for reducing high-contamination areas in the passageways is being studied.
[Related to this project]

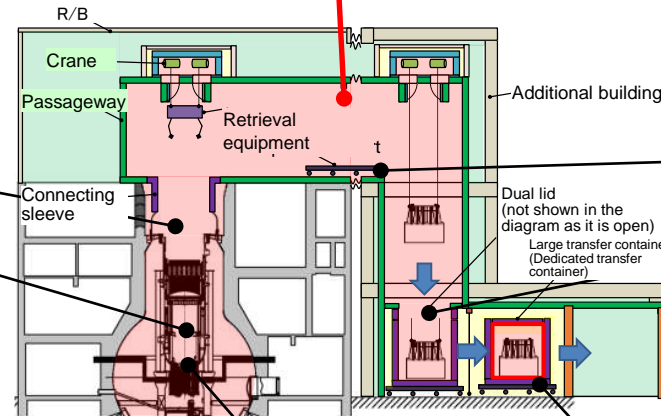

[Notes]
Colors indicate the following contamination levels
R (Red): Red (high contamination) zone
Y (Yellow): Yellow (moderate contamination) zone
G (Green): Green (low contamination) zone
(Study results as of end of FY2020 are listed.)

Cutting structures from the reactor bottom

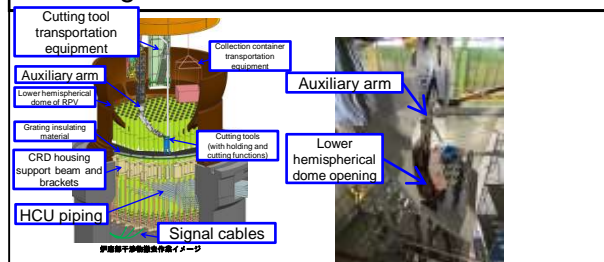

Elemental tests are conducted on further increasing the scale of retrieval (FY2019- 20)

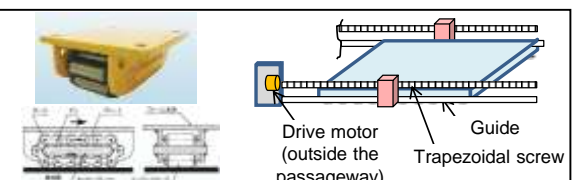

Conceptual study is conducted on further increasing the scale of retrieval (implemented in FY2019- 20)

[3] Large transportation equipment

Air-tight mechanism of the dual lid

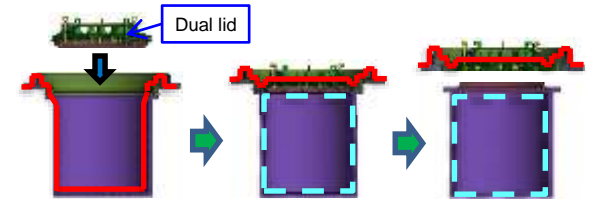

Elemental tests are being planned on the technological development (FY2020-21) related to ensuring safety during fuel debris retrieval work.

[2] Large transfer containers

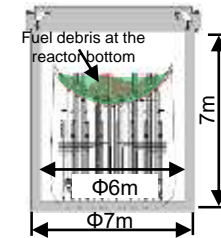

Conceptual study is conducted on further increasing the scale of retrieval (implemented in FY2019- 20)

2. Results and Contents of the Study on Top Access Method Conducted as Part of Subsidy Projects

[Correlation between the developed items by the previous projects and this project]

Project of Upgrading of Fundamental Technology (implemented in FY2017-18)

[Study of the Method for cutting pieces inside PCV]

- Implementation of elemental tests using simulated reactor bottom structures
- Estimation of throughput, identification of issues

Project of Development of Technology for Further Increasing the Retrieval Scale of Fuel Debris (implemented in FY2019- 20)

[Study of the Method for transferring the unitized structures]

- Implementation of elemental tests related to disassembling the reactor bottom
- Conceptual study related to the large transfer containers
- Study of the Method for criticality control until collection in containers

Development of Technology for Fuel Debris Retrieval Method (implemented in FY2021- 22)

[Development of technology for realizing the retrieval concept]

- Study of Method for cutting large structures
- Study of large transfer containers (main body)
- Study of large transportation equipment

Items to be studied in future

- Study of technological challenges identified during engineering and technological development etc.

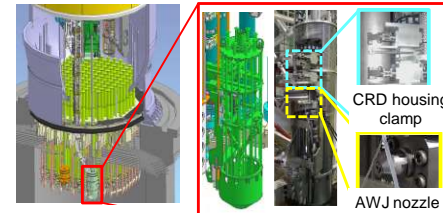

Removal of large structures from the reactor bottom

Method for cutting pieces

[Notes]
 Colors indicate the following contamination levels
 R (Red): Red (high contamination) zone
 Y (Yellow): Yellow (moderate contamination) zone
 G (Green): Green (low contamination) zone

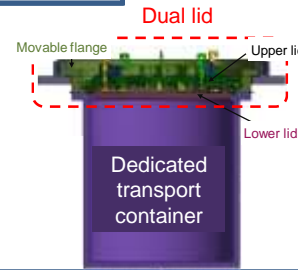

Project of Technological Development for Ensuring Safety (implemented in FY2020-21)

[Feasibility verification of the large transfer container lid]

- Development and elemental tests of the air tight mechanism for the container lid
- Study of the method for criticality control after collection in containers (during transfer)

This project

[Development of Isolation Technology to Prevent the Spread of Contamination]

- Isolation technology development and elemental tests

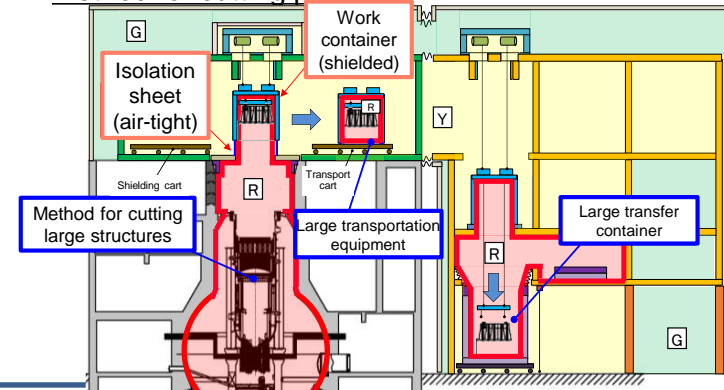

Method for transferring unitized large structures

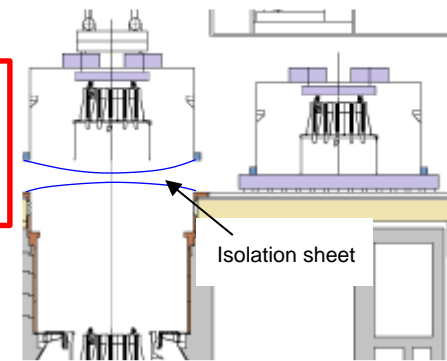

2. Results and Contents of the Study on Top Access Method Conducted as Part of Subsidy Projects

[Development results up to FY2020 (contents of studies)]

A conceptual study of the methods for reducing the high contamination area in the passageways was conducted.

[Notes]
 Colors indicate the following contamination levels*
 R (Red): Red (high contamination) zone
 Y (Yellow): Yellow (moderate contamination) zone
 G (Green): Green (low contamination) zone
 *Besides color, the main zones are marked as R, Y and G.

	(Passageway method)	(Passageway method) Revision 1 Setting up partitions using gates	(Passageway method) Revision 2 Setting up partitions using work containers
Conceptual diagram			
Merits	<ul style="list-style-type: none"> • Simple retrieval procedures • Smaller number of equipment components, smaller amount of waste 	<ul style="list-style-type: none"> • Reduction in spreading of radioactive dust resulting from cutting, to the passageway due to closed gates 	<ul style="list-style-type: none"> • Reduction in spreading of radioactive dust resulting from cutting, to the passageway due to the work containers • Reduction in spreading of radioactive dust to the passageway as the work containers are used for transporting structures as well.
Demerits	<ul style="list-style-type: none"> • Spreading of radioactive dust resulting from cutting, directly into the passageway (major accumulation of radioactive dust) 	<ul style="list-style-type: none"> • Interference of the transport cart rail and the travel drive unit when the gates close • Spreading of radioactive dust to the passageway while transporting the structures 	<ul style="list-style-type: none"> • Increase in amount of secondary waste due to addition of work containers <p>Note; Since the underside of the work container is not closed, it remains open momentarily when the container is transferred to the transport cart..</p>

(Revision 2) is considered as the primary choice for preventing spread of contamination from radioactive dust into the passageway.

However, since the underside of the work container of (Revision 2) is not closed, contamination spreads temporarily when transferring it on to the transport cart.

⇒ * The fuel debris retrieval is likely to continue for a prolonged period. If maintenance of the equipment, response actions in the event of emergencies, etc. are considered, it is desirable to reduce the extent of spread of contamination as much as possible. Hence it continues to be studied as part of the FY2021 Development of Fuel Debris Retrieval Method Project.

2. Results and Contents of the Study on Top Access Method Conducted as Part of Subsidy Projects

[Development results up to FY2020 (contents of studies)]

- ◆ Conditions concerning the work containers [(Passageway method) Revision 2: Setting up partitions using work containers]

[1] When the work container is separated, the reactor well side and the underside of the work container are closed simultaneously.

[2] Containers of different sizes are used depending on the work classification so as to reduce the weight of the work containers.

Work container for cutting

- Size of the work container such that it covers the whole reactor well area (large inner diameter)
- Minimum sheet thickness considering reduction of radiation dose from inside the reactor (thin sheet)
- Reduction in weight of work containers

Shielding the radiation dose from inside the reactor

Preventing spread of contamination during cutting work

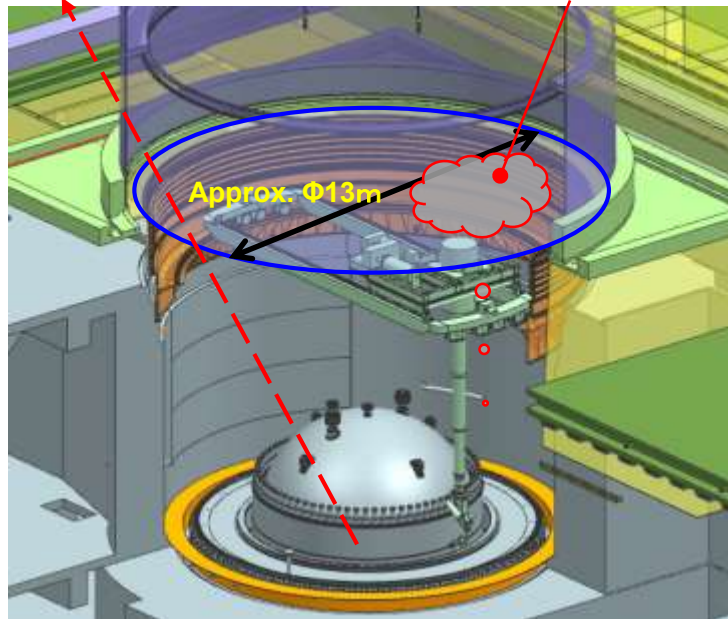

During cutting (disassembling) work (Example image)

Work containers for transfer of structures

- Minimum size corresponding to the structures to be transferred (small inner diameter)
- Sheet thickness considering reduction of radiation dose from the structures to be transferred (thick sheet)
- Reduction in weight of work containers

Shielding the radiation dose from the structures to be transferred (Internal structures, etc. have a high dose rate)

Preventing the spread of contamination from adhered substances

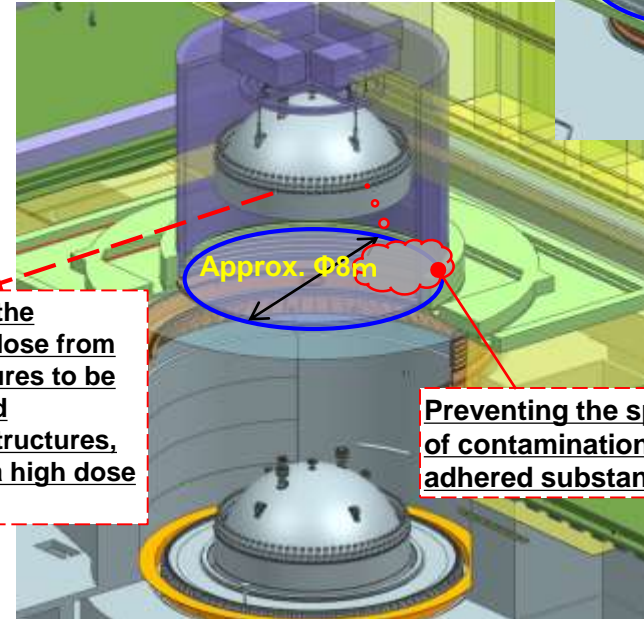

During transfer work (Example image)

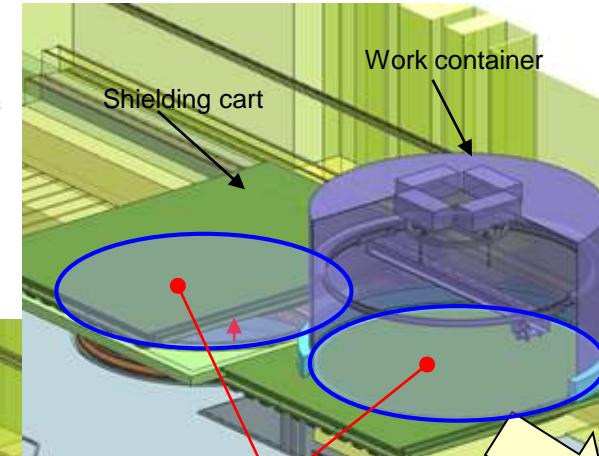

When the work container is separated, the reactor well side and the underside of the work container are closed simultaneously.

When it is transferred (common) (Example image)

3. Project Overview

3. 1. Collaboration with other projects

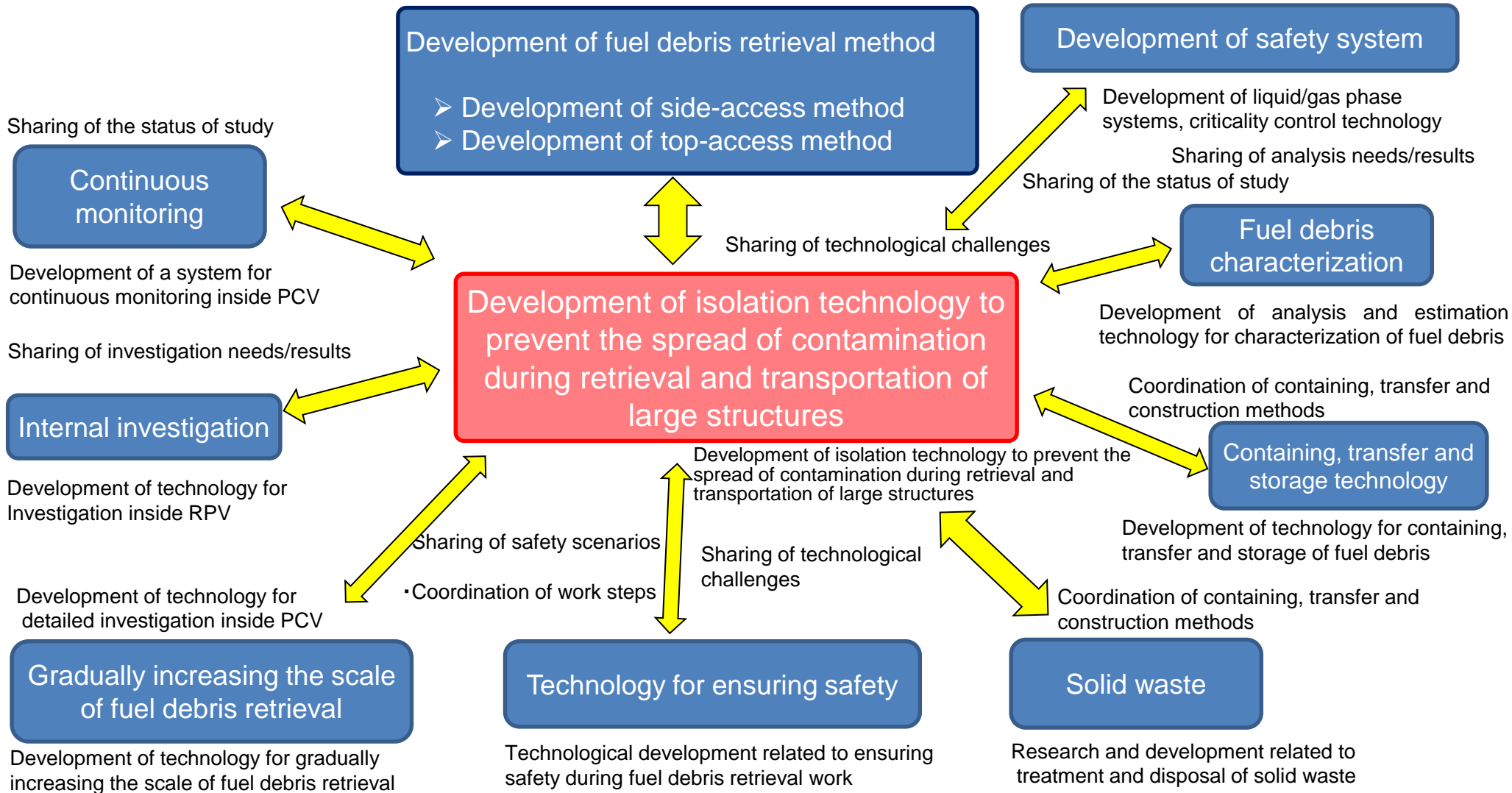

In this project, joint meetings will be conducted as required in coordination with the above-mentioned projects.

3. Project Overview

3. 2 Development items involving solicitation information of subsidized projects and implementation policy

Development items involving solicitation information of subsidized projects	Implementation policy
<p>1) Development of isolation technology to prevent the spread of contamination during removal and transportation of large structures</p>	<p>In order to enhance the throughput of retrieving fuel debris and internal structures using the top access method, development related to the method for transferring large unitized structures is being carried out since FY2019. The method for cutting the large unitized reactor internal as far as possible, pulling the cut structures up to the Reactor Building (R/B) operation floor, and transferring them to the additional building using large transport equipment, is being studied.</p> <p>Since it is necessary to plan in such a way that the passageway from the R/B operation floor to the additional building does not get contaminated as far as possible, in order to confine radioactive materials, and reduce the radiation exposure of the workers, the concept of the method for covering the contaminated structures by means of work containers during cutting work inside the reactor and while transferring the cut structures up to the additional building, or the method for preventing spread of radioactive materials to the passageway by providing an isolation mechanism when the work container is transferred from inside the reactor to the R/B operation floor, is being studied.</p> <p>In order to crystalized measures to prevent the spread of contamination, the contaminated materials generated as a result of work, the routes where these materials spread, etc. will be put together, and after clearly specifying the contaminated area class required in the passageways, technological development of equipment, operation methods, etc. concerning the isolation mechanism for preventing the spread of contamination will be carried out.</p>

3. Project overview

3. 3 Purpose of this project

- Development of isolation technology to prevent the spread of contamination during retrieval and transportation of large structures (This project)
- Development of fuel debris retrieval method (FY2021 to FY2022)

The following figure is an image illustrating the retrieval method using isolation technology such as using work containers and isolation sheets with shielding function, etc., in order to reduce the extent of contamination inside the passageways.

A structure that can co-exist with the large transfer containers and dual lid that are being currently developed, will be studied.

Isolation technology to prevent the spread of contamination (This project) → Development of isolation technology such as isolation sheet, etc. for preventing the spread of contamination from the underside of the work container (Reducing the contamination level inside the passageways, reducing the radiation exposure of workers, enhancing the operability of maintenance of cranes)

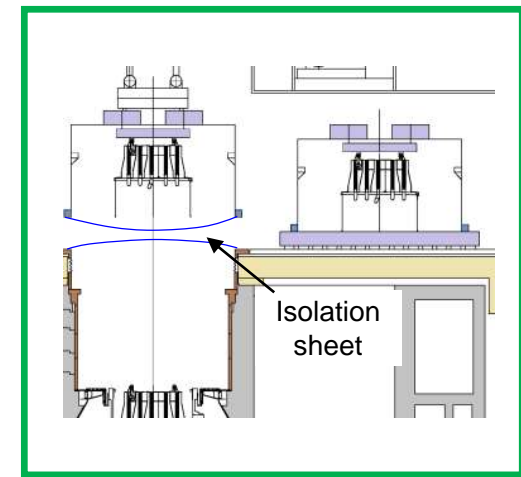
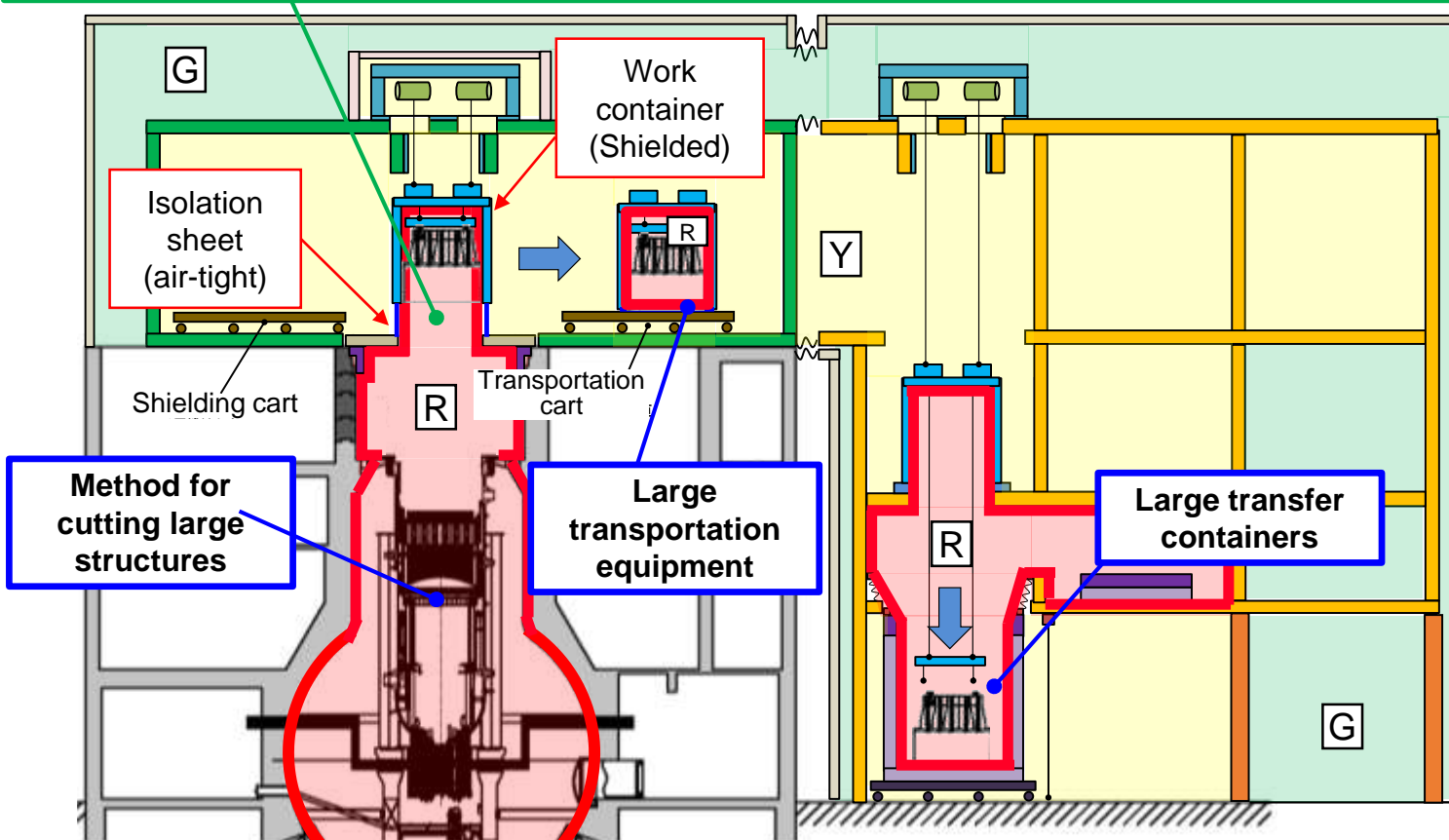

Image showing confinement by means of isolation sheet

[Notes]
 Colors indicate the following contamination levels*
 R (Red): Red (high contamination) zone
 Y (Yellow): Yellow (moderate contamination) zone
 G (Green): Green (low contamination) zone
 *Besides color, the main zones are marked as R, Y and G, and the red zone is marked with a red border.

Image showing reduction in contamination inside the passageways when work containers are used.

3. Project overview

3.4 The points of concerns while executing this project

The points of concerns while executing the project are described below.

[The points of concerns]

To proceed with the development, the following points of concerns are considered for handling efficiency and maintenance methods of remotely operated equipment

- Remote-operated maintenance should be principle because the equipment will be installed in high radiation areas.
- The contamination of the equipment and the required decontamination should be taken into consideration.
- The work area available for maintenance work is limited.
- Waste generated during maintenance work needs to be minimized as much as possible.
- Installation and handling of criticality monitoring equipment needs to be considered.

4. Implementation Schedule

■ : Planned
 ■ : Actual

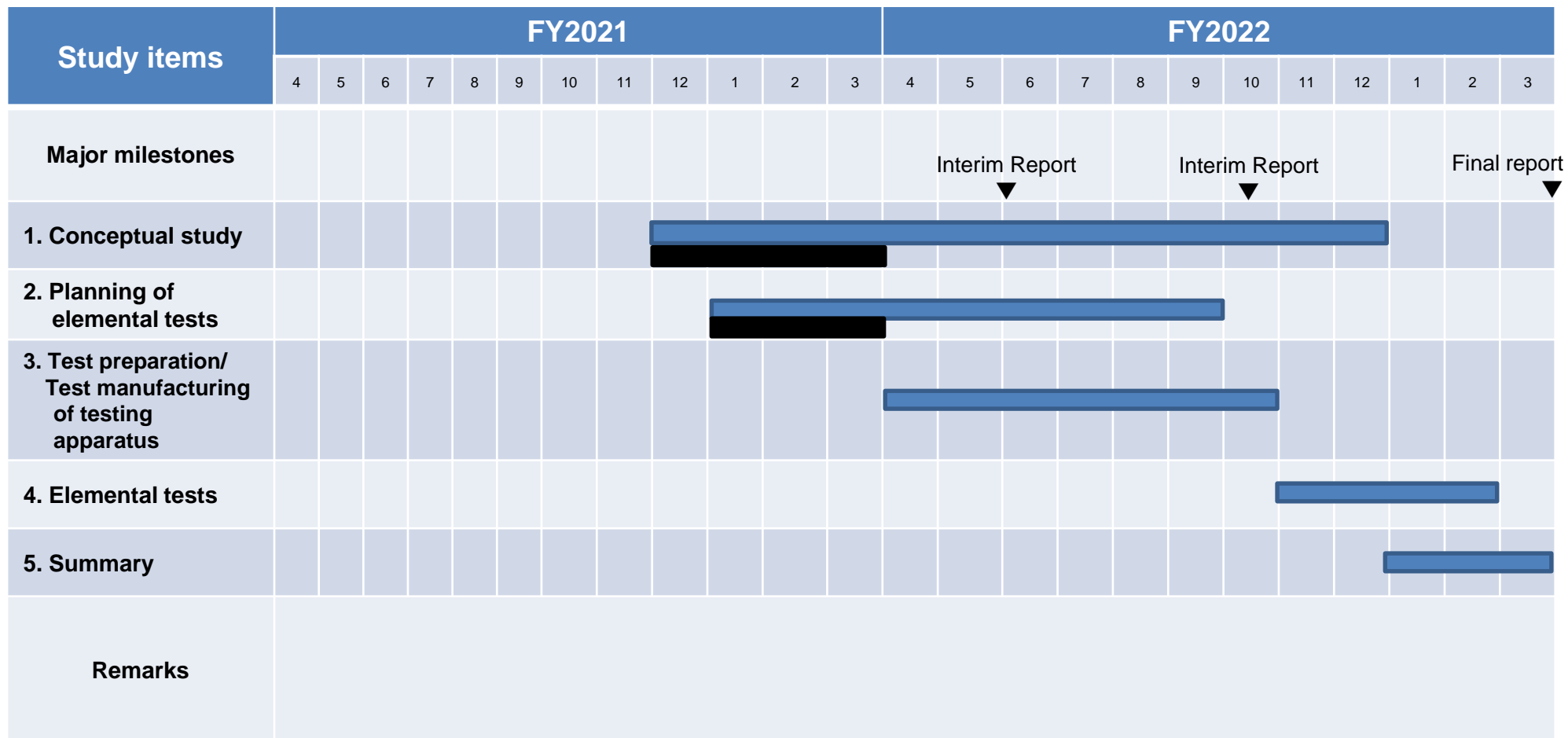

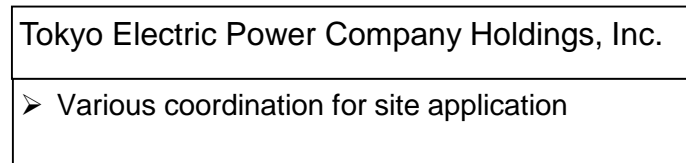
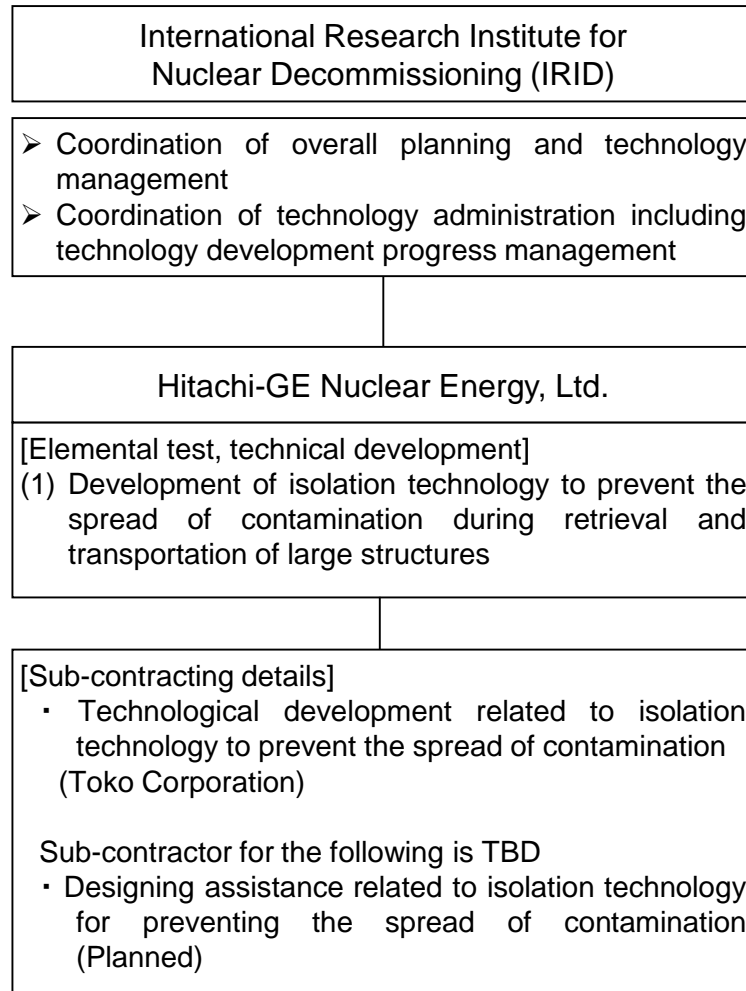

Project teams to cooperate for technological development

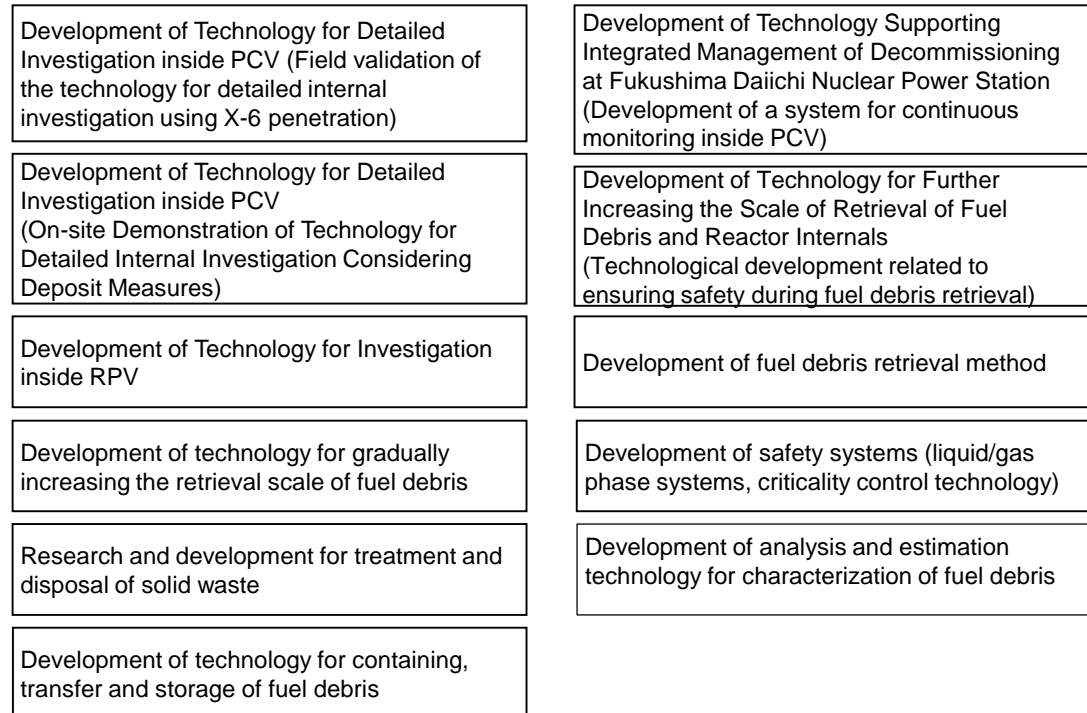

1) Development of isolation technology to prevent the spread of contamination

In order to enhance the throughput of retrieving fuel debris and reactor internal structures using the top access method, development concerning the method for transferring the large unitized structure is being carried out since FY2019. As part of this, the method for cutting the large unitized reactor internal as far as possible, pulling the cut structures up to the R/B operation floor, and transferring them to the additional building using large transport equipment, is being studied. It is necessary to plan in such a way that the passageways from the R/B operation floor to the additional building do not get contaminated as far as possible, in order to confine radioactive materials, and reduce the radiation exposure of the workers. Hence the concept of the method for covering the contaminated structures by means of work containers when the structures are cut inside the reactor and while they are transferred up to the additional building, or the method for preventing spread of radioactive materials to the passageways by providing an isolation mechanism when the work container is transferred from inside the reactor to the R/B operation floor, is being studied.

During this project, in order to implement these measures to prevent the spread of contamination, the contaminated materials generated as a result of work, the routes where these materials spread, etc. will be put together, and after clearly specifying the contaminated area class required in the passageways, technological development of equipment, operation methods, etc. concerning the isolation mechanism for preventing the spread of contamination will be carried out. At the time of development, evaluation and selection will be performed from the perspective of confinement performance, certainty and operability of remote operations, robustness and durability, of inspection and maintenance, etc. and the most appropriate technology will be studied. Also, on-site applicability will be evaluated by conducting elemental tests with the help of a simulated facility that use the studied technology.

1) Development of isolation technology to prevent the spread of contamination

[Issues]

- There is a risk of spreading contamination throughout the passageways if the passageways are airtight.
- It is necessary to prevent the spread of contamination considering on-site work efficiency of fuel debris retrieval work.

[Implementation details]

- The contaminated materials generated from fuel debris retrieval work and the routes where these materials spread, etc. will be clarified, and the contaminated area class required in the passageways will be clearly specified.
- The methods and procedures for confining contaminated materials during retrieval and transportation of large structures will be studied.
- Isolation mechanism for preventing the spread of contamination will be evaluated and selected from the perspective of confinement performance, certainty and workability of remote operations, robustness and durability, efficiency of inspection and maintenance, etc. and the most appropriate technology will be studied.
- On-site applicability of the technologies studied will be evaluated by conducting elemental tests using a simulated test facility to verify manufacturing efficiency, operability of collection into the equipment, air-tightness, etc.

[Expected outcome]

- Presentation of the method for preventing spread of contamination while transporting contaminated large structures.

6. Implementation Items of This Project

1) Development of isolation technology to prevent the spread of contamination

[Classification of the contaminated area classifications required in the passageways]

◆ Objective of the condition of area inside the passageways

[Notes]
 Colors indicate the following contamination levels*
 R (Red): Red (high contamination) zone
 Y (Yellow): Yellow (moderate contamination) zone
 G (Green): Green (low contamination) zone
 *Besides color, the main zones are marked as R, Y and G, and the red zone is marked with a red border.

● During fuel debris retrieval work

[1] Reduction of public exposure

- Reduction of dose rate at the site boundary
- Prevention of leakage of radioactive dust into the environment

[2] Reduction of exposure of workers

- Remote operation/automation

● During maintenance and inspection work

[1] Reduction of public exposure

- Reduction of dose rate at the site boundary
- Prevention of leakage of radioactive dust into the environment

[2] Reduction of exposure of workers

- Remote operation/automation Changes to be made during this development

Improvement in work environment: Direct maintenance by workers can be expected by preventing spread of contamination inside the passageways. (Stationary equipment inside the passageways, such as large cranes, etc.)

Reduction of dose rate at the site boundary
(Passageway + Work container shielding)

Prevention of leakage of radioactive dust into the environment
(Passageways + Confinement of work containers)

Reduction of dose rate inside the passageways
(Shielding by shielding cart)

Prevention of leakage of radioactive dust inside the passageways
(Closing of the reactor well side partition)

Reduction in contamination of the inner surface inside the passageways

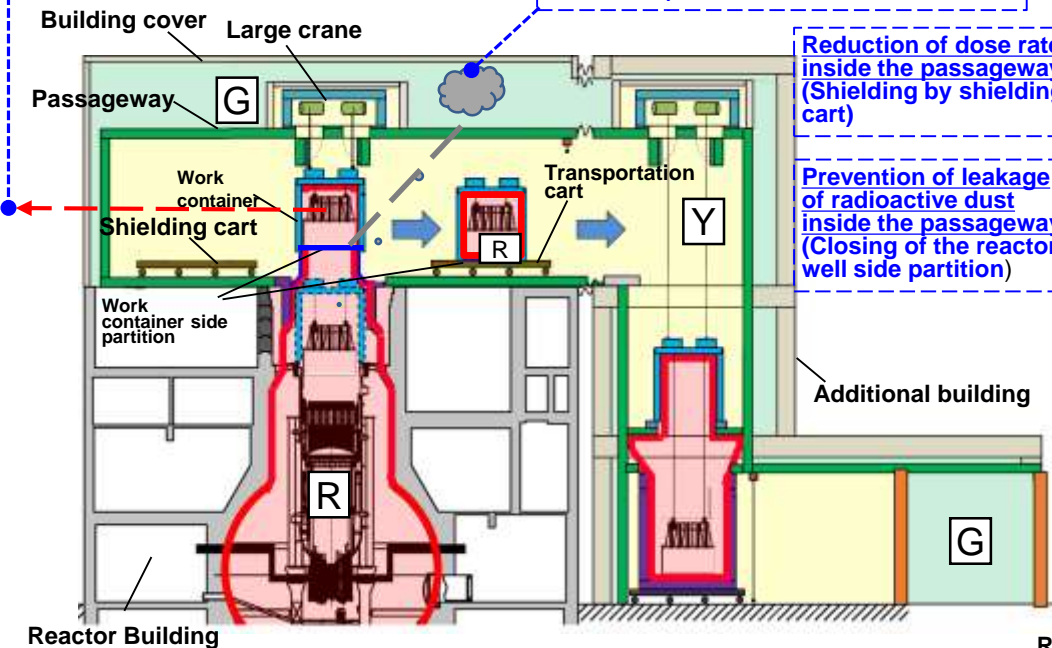

During fuel debris retrieval work

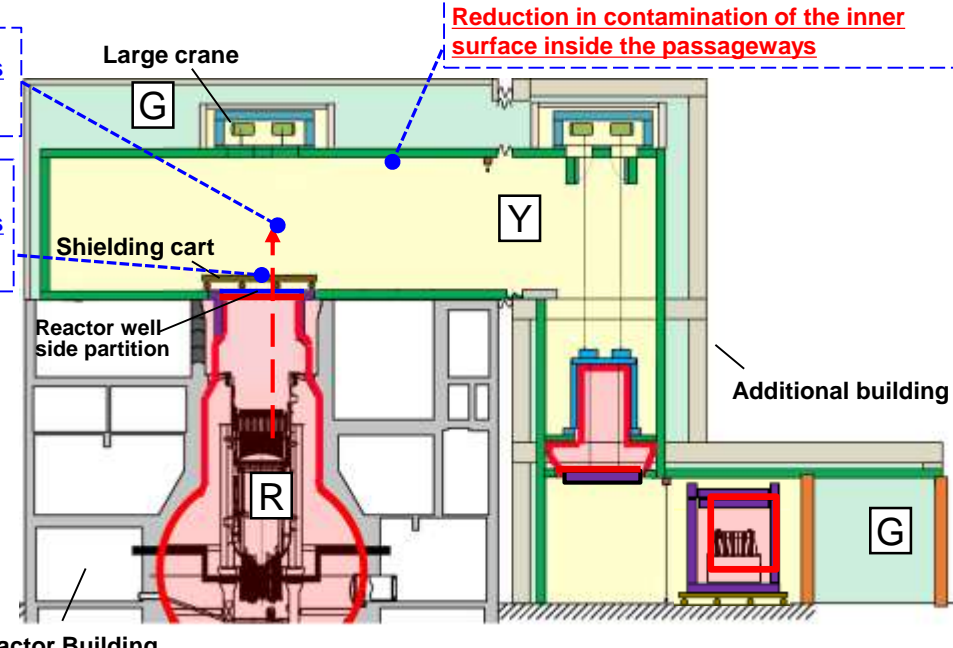

During maintenance and inspection work

1) Development of isolation technology to prevent the spread of contamination

[Concept of confinement of contaminants during removal and transportation of large structures]

◆ Confinement by means of isolation mechanism

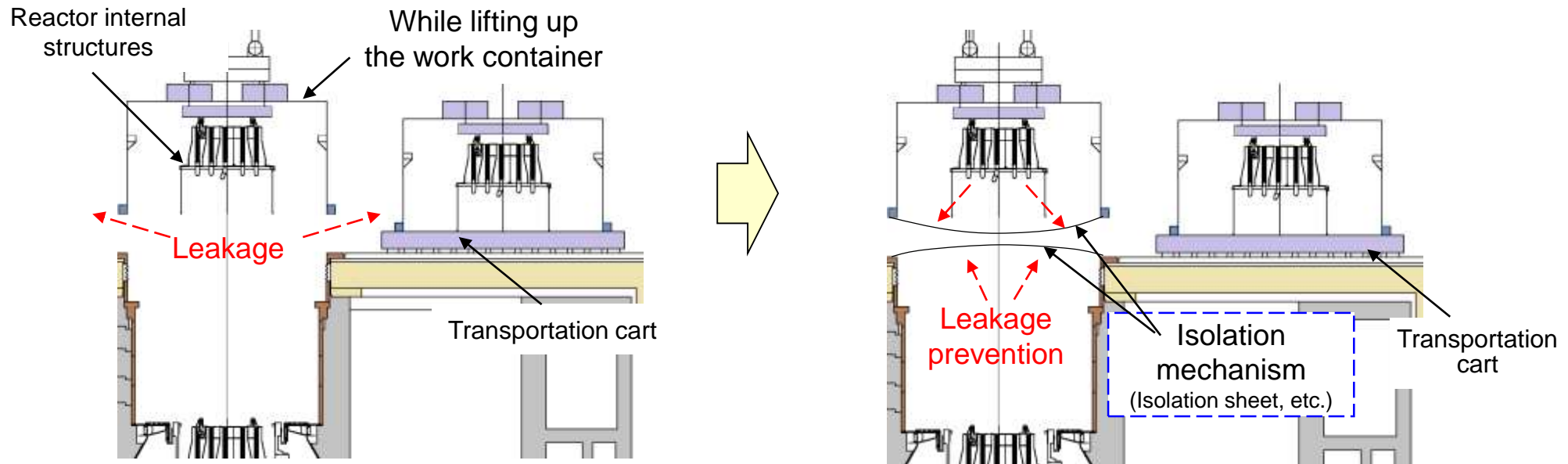

* Since the lower end of the work container is not closed, it remains open temporarily at the time of transferring onto the transportation cart.

* Preventing spread of contamination from the structures inside large work containers, and preventing the spread of contamination from inside the reactor



1) Development of isolation technology to prevent the spread of contamination

[Study of the most appropriate technology related to the isolation mechanism]

◆ Comparison of the method for closing the underside of the work container at the time of separating the work container

(Results of primary comparison)

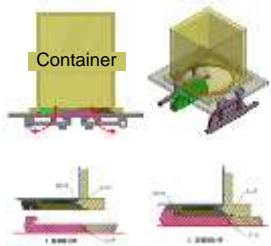
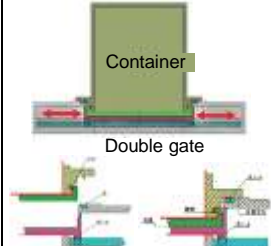
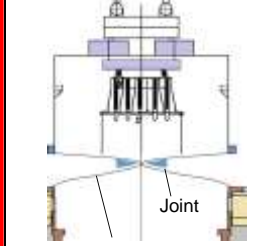
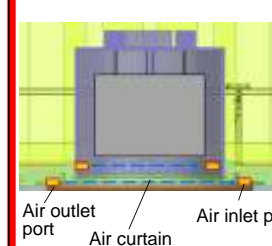
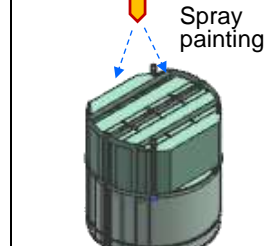
○: Good ×: Unacceptable

No	Item	Opening/closing type		Welding type	Trap type	Shatter-proof type
		Double door	Double gate	Isolation sheet	Air curtain	Surface painting
1	Outline	<ul style="list-style-type: none"> Air-tight lids are installed on the container side as well as the reactor well side, to which the container is connected, and opening and closing is performed by rotating the container in its entirety while both lids are in contact and closely adhered to each other. 	<ul style="list-style-type: none"> Air-tight gates are provided on the container side as well as the reactor well side, and opening/closing is performed by sliding the container while both gates are in contact and closely adhered to each other. 	<ul style="list-style-type: none"> A middle portion of a cylindrical sheet that connects the container side and the reactor well side is squeezed and welded/cut. 	<ul style="list-style-type: none"> Air inlet and outlet ports are provided on the container side, and the reactor well side such that the ports face each other to form an air curtain and the container is then separated. 	<ul style="list-style-type: none"> The source of contamination on the surface of the structures is solidified and peeled off using paint, etc. to prevent scattering. 
2	Confining efficiency Gas phase (particles)	○ • Gas phase (particles) can be confined	× • Leakage of contaminants from the sides when the gates are opened	○ • Gas phase (particles) can be confined	× • It is difficult to completely confine the gas phase (particles) • According to the JPDR dismantling field test (results), concentration ratio in the air on both sides of the air curtain was approx. 1/30*1.	× • It is difficult to properly paint the inner surfaces and crevices of the reactor internal structures.
3	Confinement efficiency Liquid phase (dripping of water droplets)	○ • Can be collected on the container side lid	○ • Can be collected on the container side gate	○ • Can be collected on the container side underside sheet	× • It is difficult to collect the water droplets	× • Dealing with water droplets on the surface is a challenge
4	Presence of interferences while handling	× • Interferes with the reactor well side while opening 	○ • Space is secured on the underside of the passageway	○ • Space is secured on the underside of the passageway	○ • Space is secured on the underside of the passageway	— (Opening / closing is not required)
5	Whether or not switching of work containers of different sizes is possible	× • Both lids need to match in size and shape. • Everything including the lid on the reactor well side needs to be replaced.	× • Both gates need to match in size. • Everything including the gate on the reactor well side needs to be replaced.	○ • Sheets of different sizes can be layered (example provided on the next page)	○ • The inlet and outlet ports are provided in accordance with the container side dimensions	— (Opening / closing is not required)
6	Conclusion	×	×	○	×	×

Note *1) Source: Journal of the Atomic Energy Society of Japan, Volume 38, Issue No. 7 (1996) "Results and Outline of JPDR Dismantling Demonstration Project"

The isolation sheet was selected for primary comparison. Under review upon further addition to the evaluation axis (durability, maintenance efficiency, etc).

6. Implementation Items of This Project

1) Development of isolation technology to prevent the spread of contamination

[Study of the most appropriate technology related to the isolation mechanism]

◆ Method for closing the underside of the work container at the time of separating the work container

(Additional explanation related to isolation sheets)

[1] Highly flexible confinement method that can be applied to containers of different sizes

[2] Simple methods (sheet-like material, etc.) can be applied as it is used inside the passageways (primary boundary).

→ Development of confinement method using sheet-like material (isolation sheet)

FY2014 Subsidy Projects*

Elemental tests of isolation sheets that enclose the contaminated structures
(Study of materials, manufacturing efficiency of large sheets, etc.)



Simple cylinder made of polyurethane sheet



Simple cylinder made of composite sheet (prototype 1)



Bellows like sheet made of composite sheet (prototype 1)

FY2015 - FY2016 Subsidy Projects**

1/4 scale model test for every work step
(Application of sheets for preventing spread of contamination)



Zipper closing part

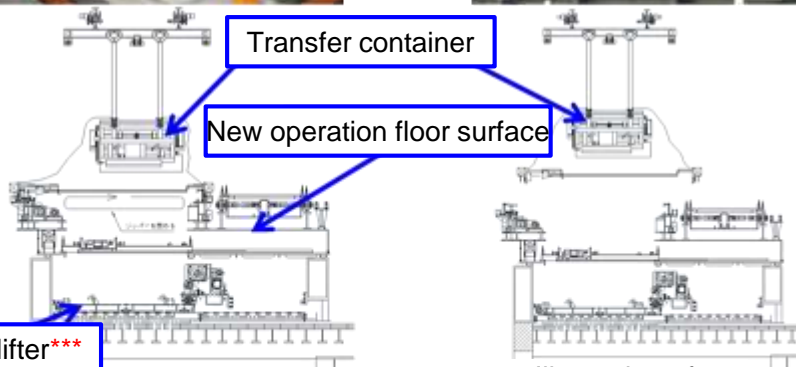

Transfer container

New operation floor surface

DSP lifter***

Illustration of transfer using sheet for preventing spread of contamination

Illustration of detachment of the zipper closure

***DSP: equipment storage pool

Results of past subsidy projects

Application of results

Development of isolation sheets considering combination with the work container

6. Implementation Items of This Project

1) Development of isolation technology to prevent the spread of contamination

[Study of the procedures for confinement of contaminants during retrieval and transportation of large structures]

◆ Study of procedures for confinement using isolation sheets

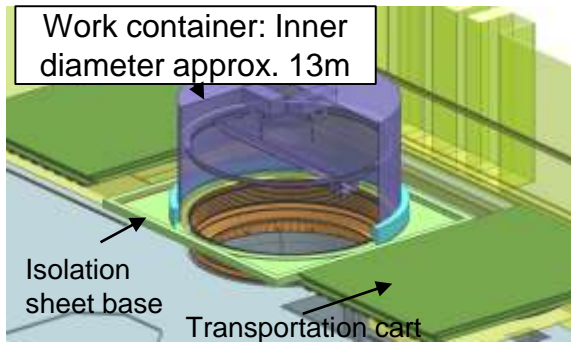

[1] While using work container

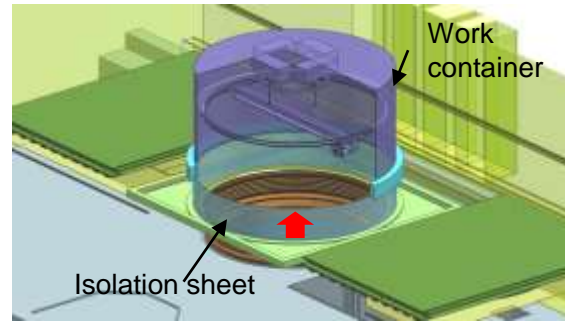

[2] While lifting up the work container

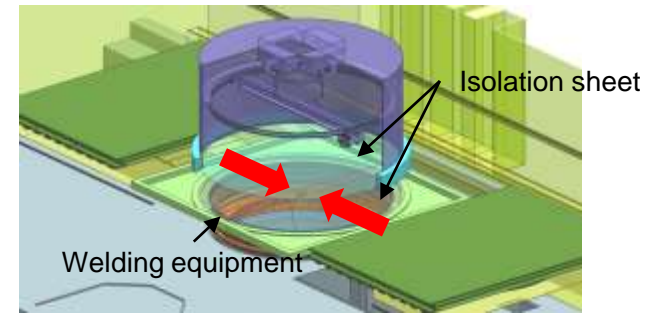

[3] Isolation sheet squeezing, welding, cutting/moving the work container

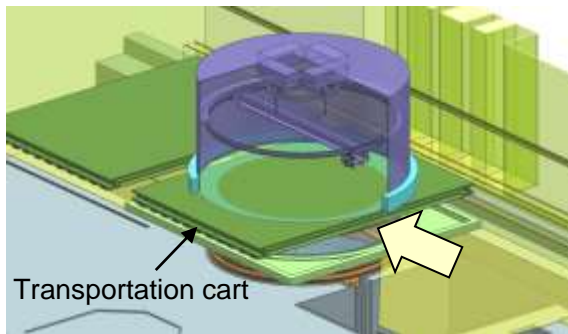

[4] Moving of the transportation cart

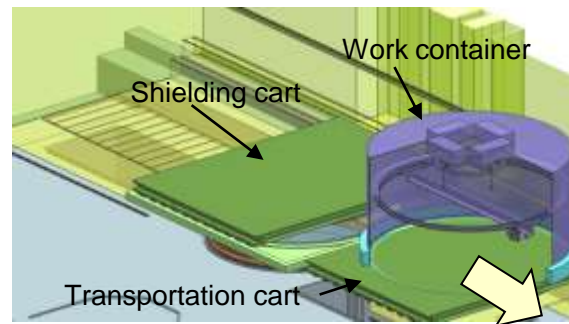

[5] Transfer of work container

* The above-mentioned procedures including the procedures for collecting the structures in large transfer containers, the method for replacing the isolation sheet, etc. are being crystallized.

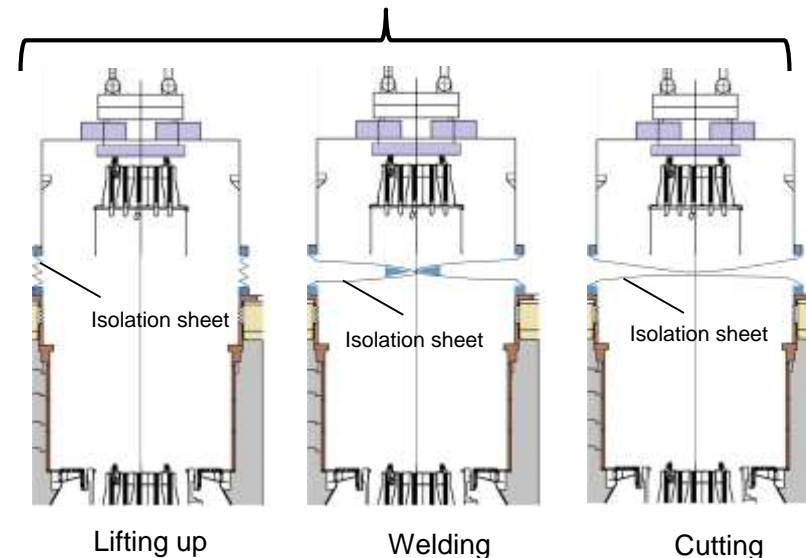

Closing the underside of the work container with inner diameter approx. 13m

6. Implementation Items of This Project

1) Development of isolation technology to prevent the spread of contamination

[Study of the procedures for confinement of contaminants during retrieval and transportation of large structures]

[Notes]
 Colors indicate the following contamination levels*
 R (Red): Red (high contamination) zone
 Y (Yellow): Yellow (moderate contamination) zone
 G (Green): Green (low contamination) zone
 *Besides color, the main zones are marked as R, Y and G, and the red zone is marked with a red border.

◆ Overview of work container

The work container being studied as part of the Project for Development of Fuel Debris Retrieval Method is shown below.

The use of containers of different sizes depending on the work classification so as to reduce the weight of the work containers, is being studied.

Table: Functional requirements of the work container in accordance with the contents of work

Functional requirements	While cutting	While transferring
Work	Must be able to mount large disassembling equipment for cutting work	Must be able to mount a crane that can place the structures in the work container
Shielding	Must be able to shield the radiation dose from inside the reactor during cutting work	Must be able to shield the structures placed inside the work container



If the work containers are used in common, they must be extremely large and heavy. Hence different work containers will be used depending on the work classification.

	Work container for cutting	Work container for transfer of structures
Illustration of installing the work container		
Remarks	The large equipment for cutting can be installed and radiation dose from inside the reactor during cutting can be shielded.	A crane that are stored in the work containers can be installed, and the structures stored inside the work containers can be shielded.

6. Implementation Items of This Project

1) Development of isolation technology to prevent the spread of contamination

[Study of the procedures for confinement of contaminants during retrieval and transportation of large structures]

◆ Example of using different work containers

While lifting up reactor internal structures or the reactor bottom part, the work container is installed on the surface of the RPV flange, considering streamlining of shielding and the lifting range of the crane.

[Notes]
 Since the inside of the work container is red (high contamination) zone, it is marked with red color.
 (This page mainly consists of explanation related to work containers. Hence considering visibility, contaminated areas other than the work container have not been marked.)

Structure	In the reactor well	Reactor internal structures	Reactor bottom part
Work container installation location	On the operation floor	On the RPV flange surface	On the RPV flange surface
Illustration of installing work container			
Remarks	Used while removing the PCV head, RPV head insulating material, RPV head	Used while removing the reactor core	Since the weight of the reactor bottom part is approx. 250ton, and needs to be lifted 20m or more, a larger crane is used for the reactor bottom part.

Table Using different work containers in accordance with the structures (Current proposal)*

Structure	Work container installation location	While cutting	While transferring
In the reactor well	On the operation floor	Work container A	Work container B
Reactor internal structures	On the RPV flange surface	Work container C	Work container D
Reactor bottom part			Work container E

* With regards to using different work containers, after studying the series of work steps involved, a study will be conducted once again to check whether or not the no. of containers can be reduced by streamlining the work steps.

The work containers A to E in the table on the left are assumed to be different in terms of their size, shielding thickness, etc.
 (Under detailed examination)

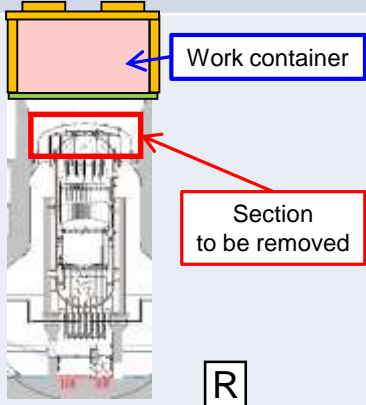
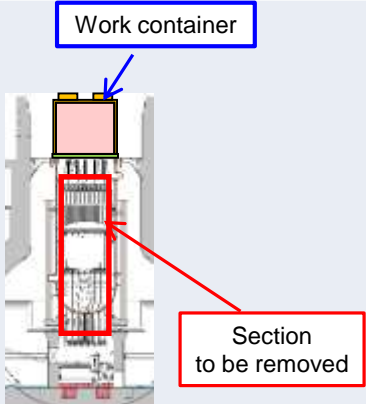
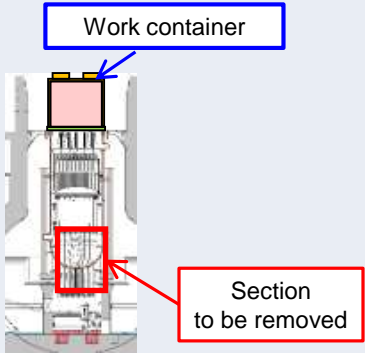
6. Implementation Items of This Project

1) Development of isolation technology to prevent the spread of contamination

[Study of the procedures for confinement of contaminants during retrieval and transportation of large structures]

◆ Removal of shield plug

The proposed shield plug removal steps being studied under the Project for Development of Fuel Debris Retrieval Method are indicated below.

1. Carrying-in the shield plug disassembling equipment

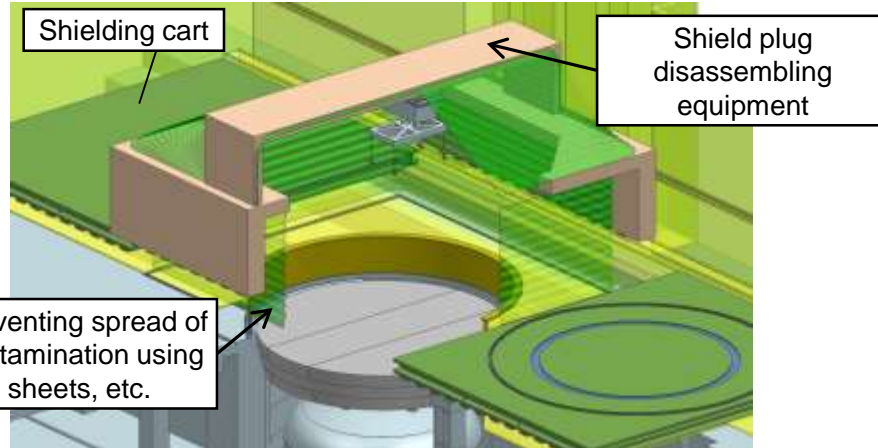

2. Lifting up the shield plug

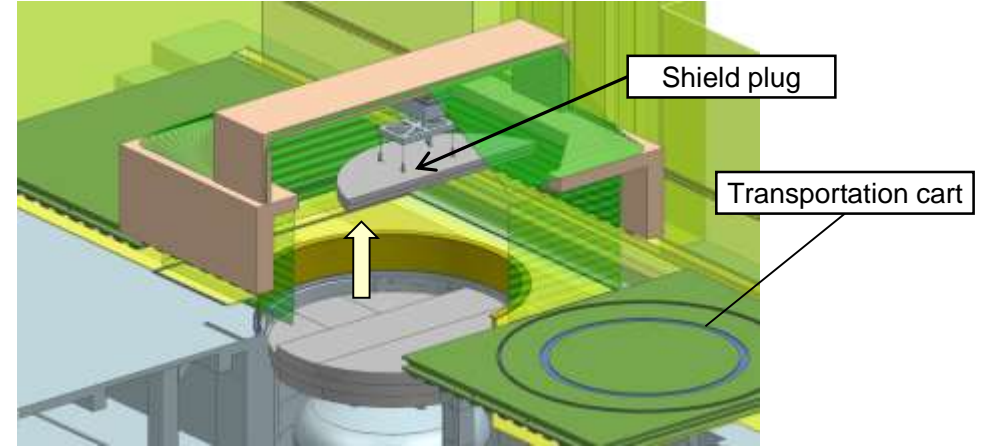

3. Moving the transportation cart under the plug and loading the plug

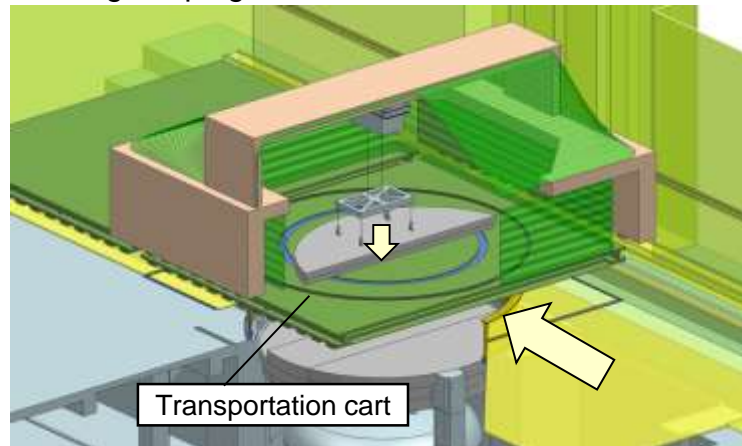

4. Moving the shield plug disassembling equipment, the transportation cart and the shielding cart as a single unit

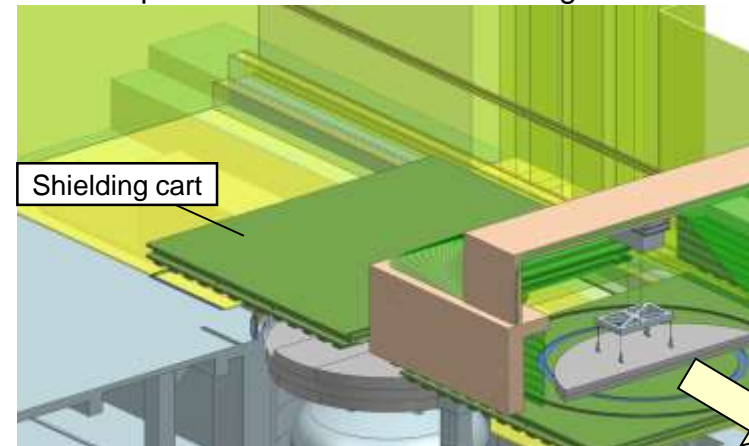

6. Implementation Items of This Project

1) Development of isolation technology to prevent the spread of contamination

[Study of the procedures for confinement of contaminants during retrieval and transportation of large structures]

◆ Outline of isolation sheet base installation work

After removing the shield plug, the base for installing the isolation sheet is installed.

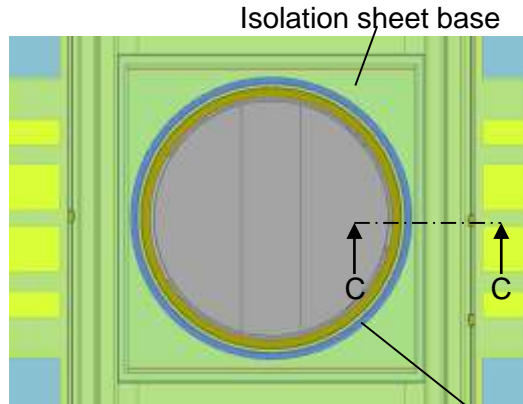
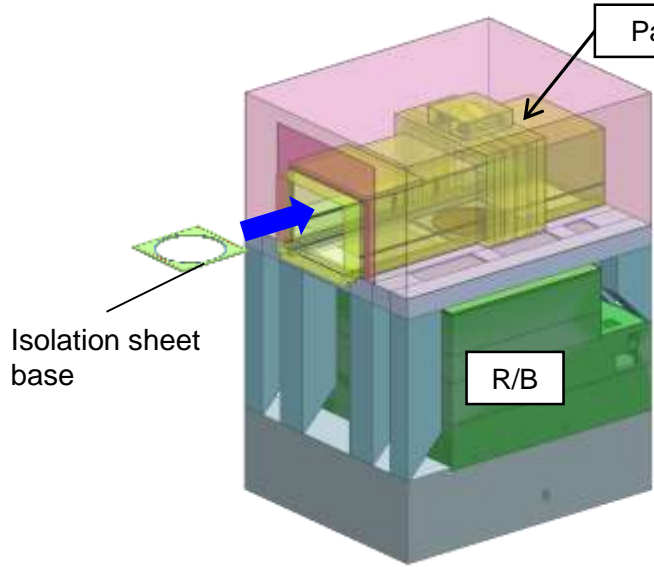

View B - B Water seal of the isolation sheet base

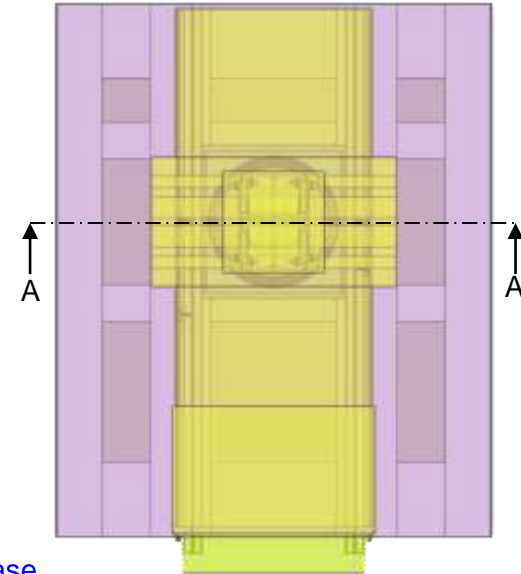

Layout drawing

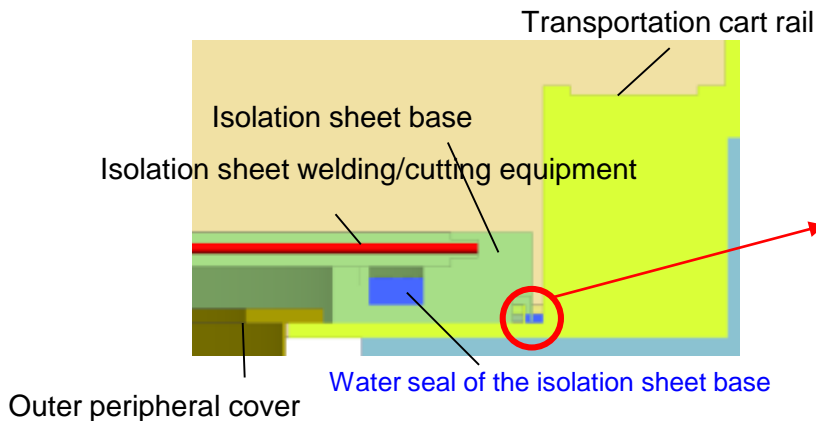

Cross-section C - C

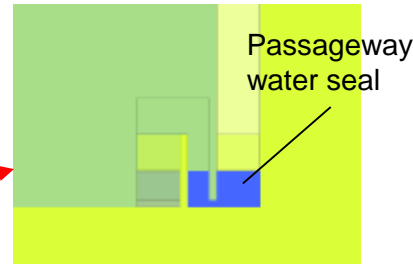

The outer periphery of the isolation sheet base is sealed by installing it inside the water seal

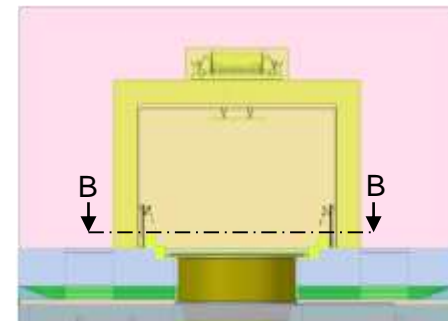

View A - A (Cross section of the center of the well)

6. Implementation Items of This Project

1) Development of isolation technology to prevent the spread of contamination

[Study of the procedures for confinement of contaminants during removal and transportation of large structures]

◆ Illustration of the isolation sheet installation

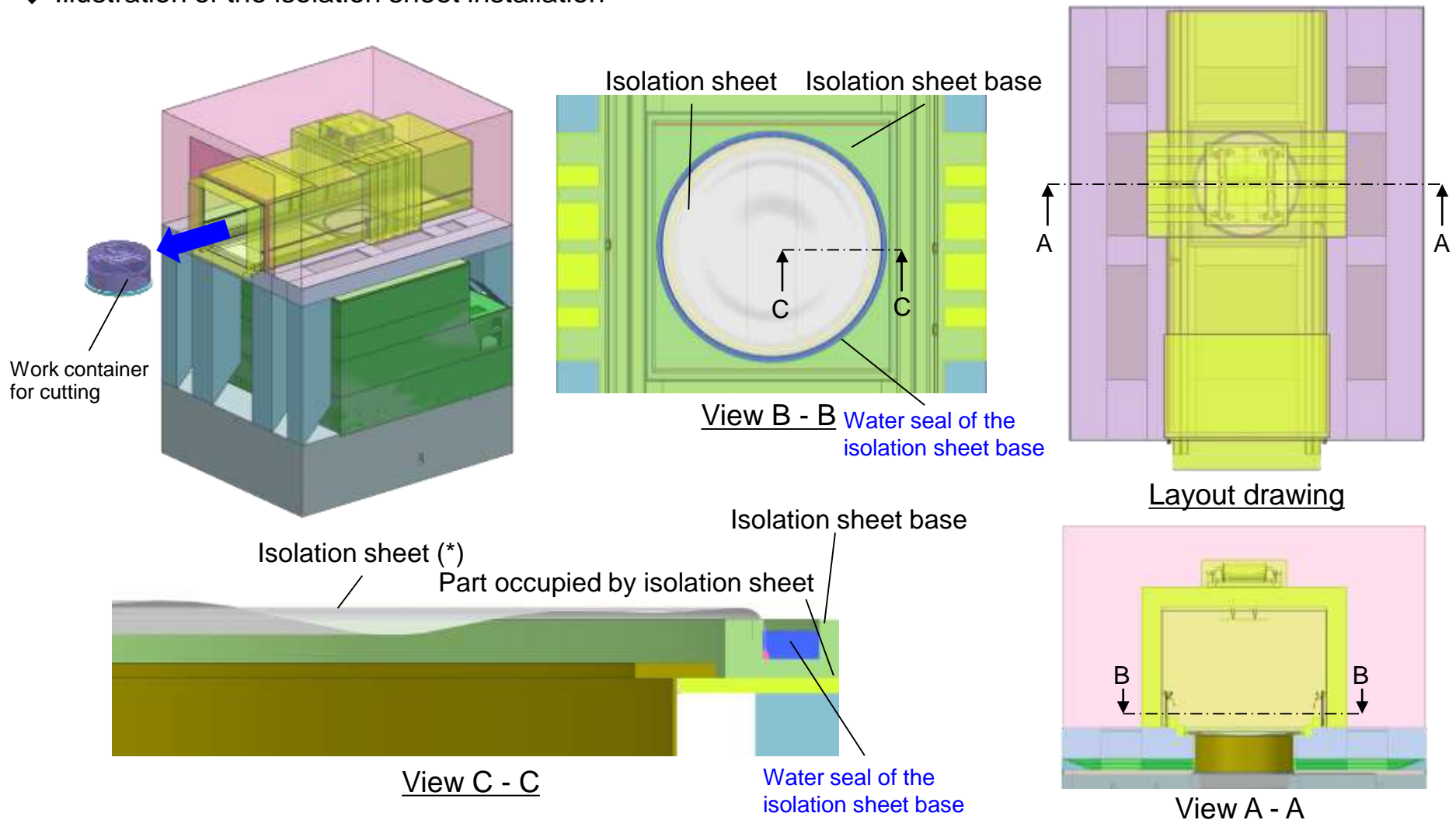

(*) Installation image
Since it is actually pulled by negative pressure, it gets pulled inside the reactor.

(Cross section of the center of the well)

6. Implementation Items of This Project

1) Development of isolation technology to prevent the spread of contamination

[Study of the procedures for confinement of contaminants during retrieval and transportation of large structures]

◆Dryer removal work steps (1/3) *Pre-condition: The cutting work has been completed by means of the disassembling equipment and work container for cutting. Changes in the contamination zones in association with transfer procedures and transfer work are indicated below, with the dryer removal (transfer) work steps as an example.

[Notes]
 Colors indicate the following contamination levels*
 R (Red): Red (high contamination) zone
 Y (Yellow): Yellow (moderate contamination) zone
 G (Green): Green (low contamination) zone
 *Besides color, the main zones are marked as R, Y and G, and the red zone is marked with a red border.

1. Carrying-in work containers for transferring structures

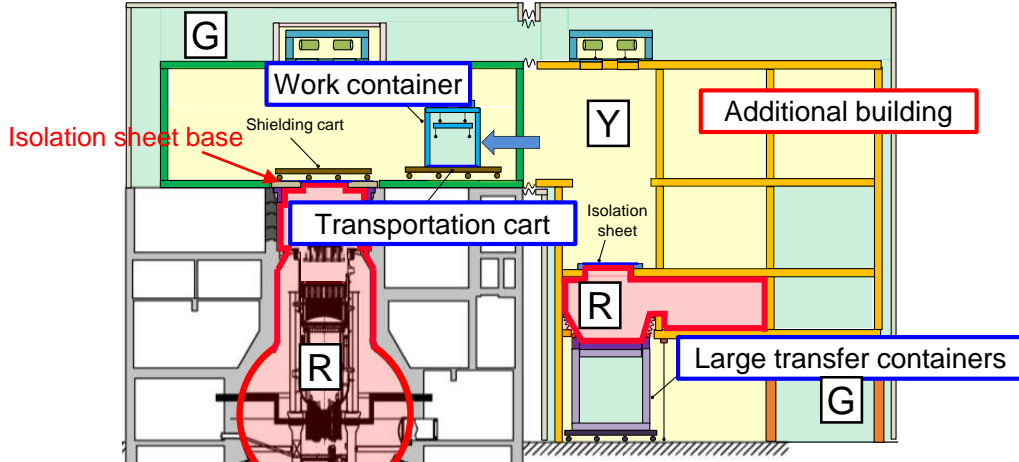

2. Transporting the work containers and moving the shielding cart

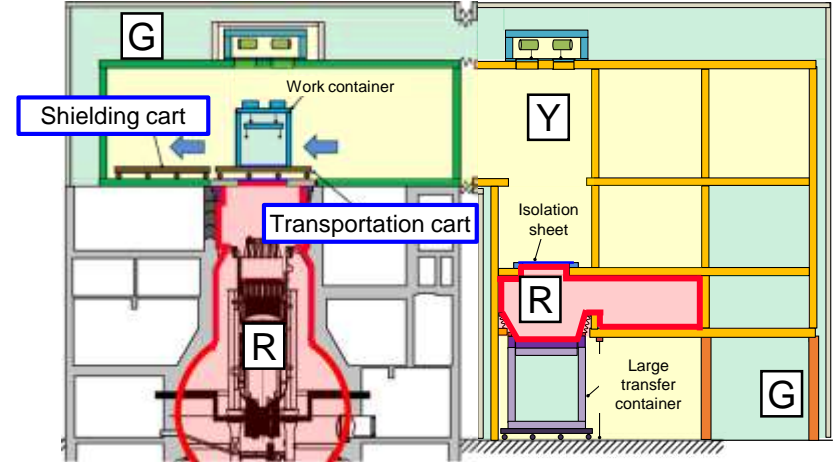

3. Retreating of transportation cart

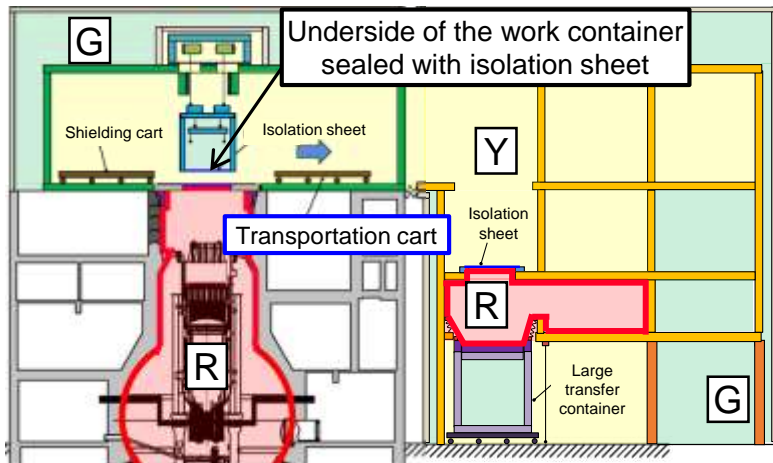

4. Suspending the work container and cutting the isolation sheet on the underside of the work container

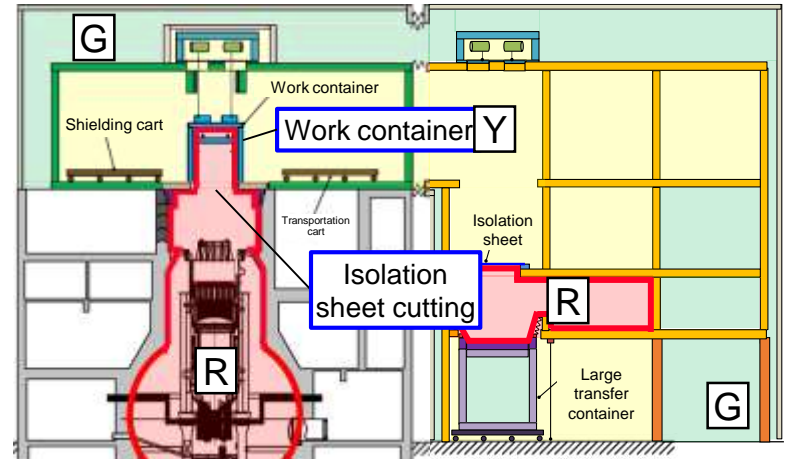

6. Implementation Items of This Project

1) Development of isolation technology to prevent the spread of contamination

[Study of the procedures for confinement of contaminants during retrieval and transportation of large structures]

◆Dryer removal work steps (2/3)

[Notes]
Colors indicate the following contamination levels*
R (Red): Red (high contamination) zone
Y (Yellow): Yellow (moderate contamination) zone
G (Green): Green (low contamination) zone
*Besides color, the main zones are marked as R, Y and G, and the red zone is marked with a red border.

5. Removing the dryer

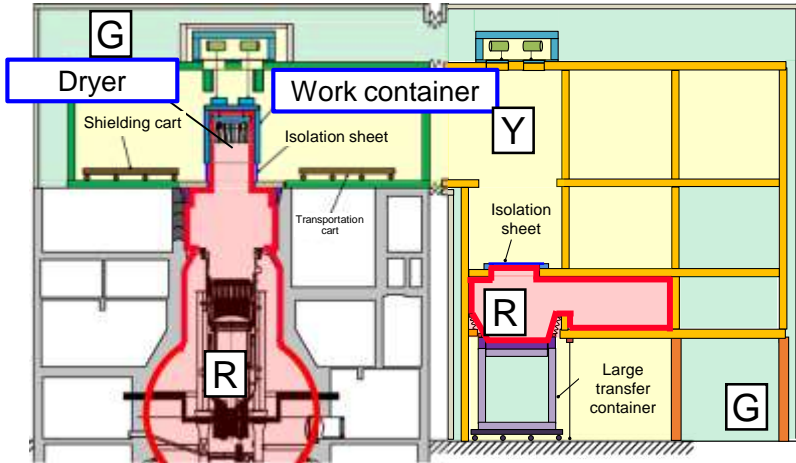

6. Welding and cutting the isolation sheet

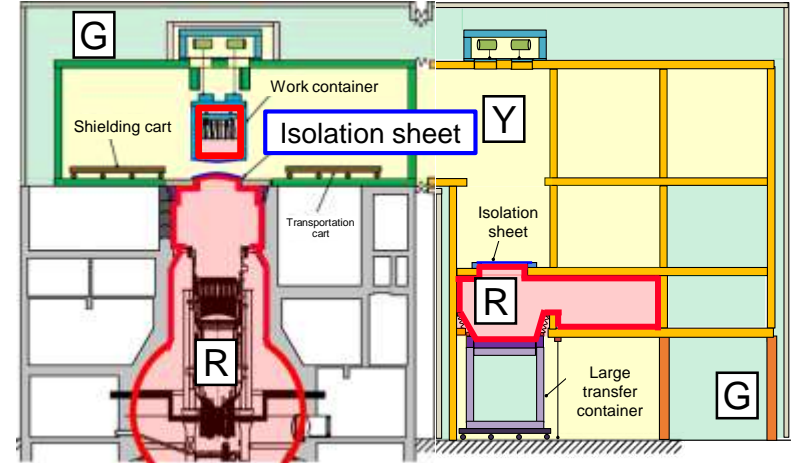

7. Moving the transportation cart

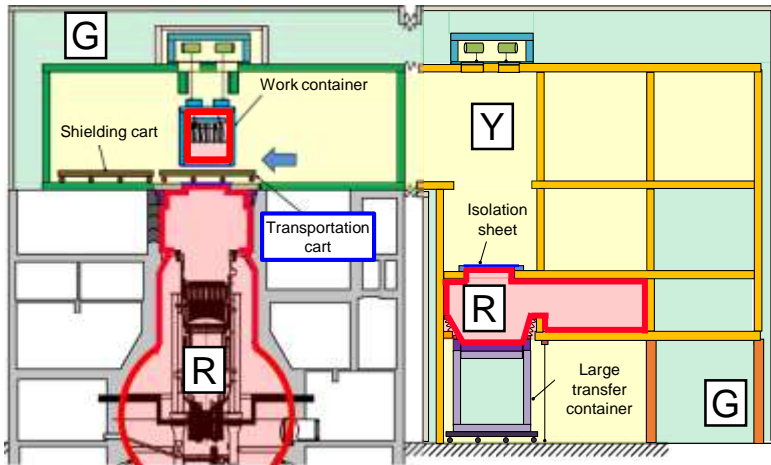

8. Suspending the work container, and positioning the dryer

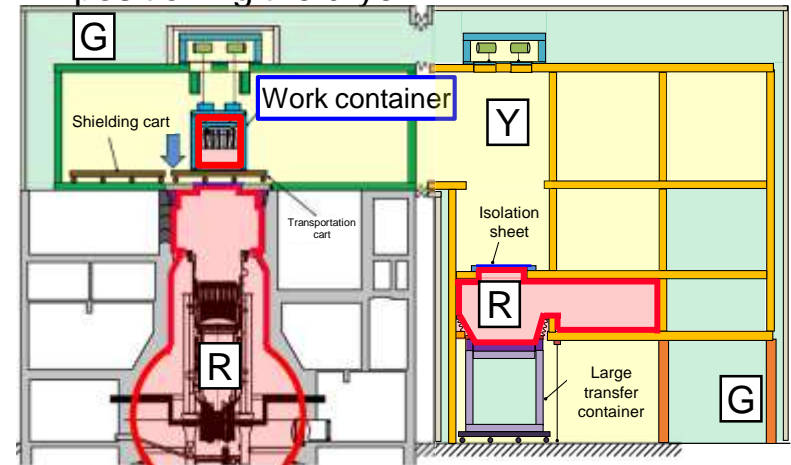

6. Implementation Items of This Project

1) Development of isolation technology to prevent the spread of contamination

[Study of the procedures for confinement of contaminants during retrieval and transportation of large structures]

◆ Dryer removal work steps (3/3)

[Notes]
 Colors indicate the following contamination levels*
 R (Red): Red (high contamination) zone
 Y (Yellow): Yellow (moderate contamination) zone
 G (Green): Green (low contamination) zone
 *Besides color, the main zones are marked as R, Y and G, and the red zone is marked with a red border.

9. Transporting the work containers and moving the shielding cart

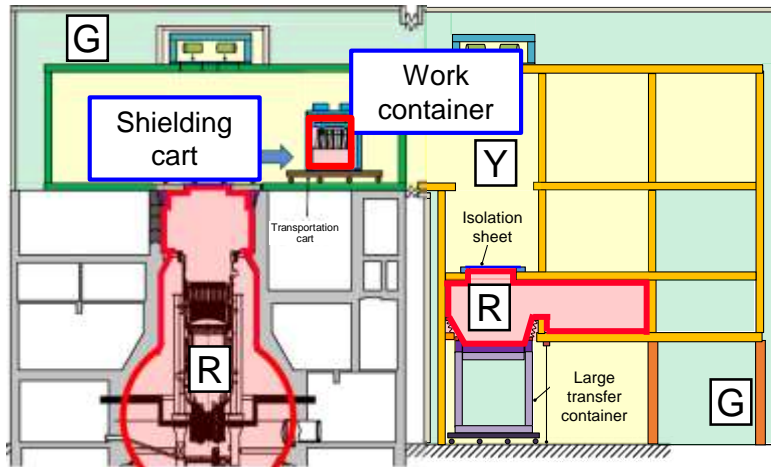

1) Development of isolation technology to prevent the spread of contamination

[Study of the procedures for confinement of contaminants during retrieval and transportation of large structures]

◆ Outline of the RPV head removal work

Images illustrating transfer of the RPV head while ensuring shielding and air-tightness using work containers, which is being studied under the Project for Development of Fuel Debris Retrieval Method, are given below.

1. Carrying-in the work container for cutting

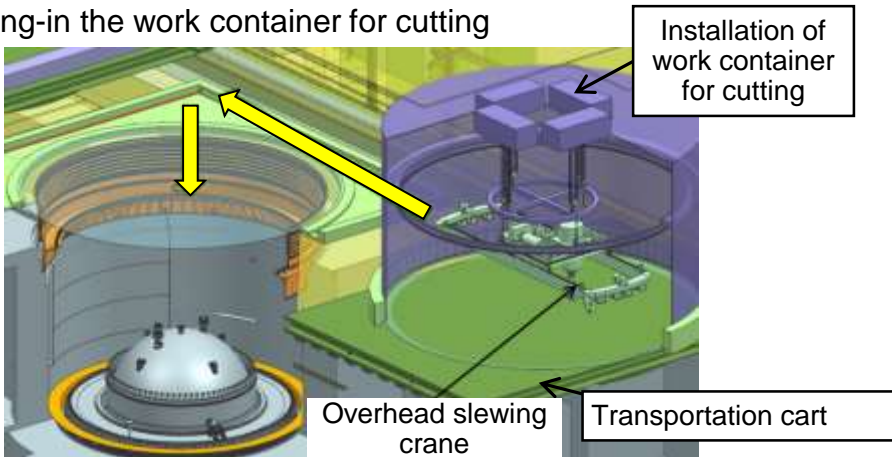

2. Cutting the RPV head bolt

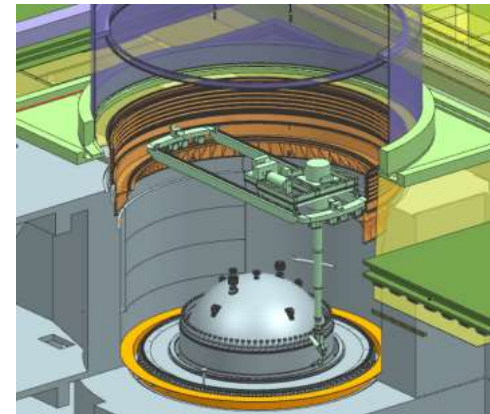

3. Retreating of the work container for cutting, carrying-in the work container for transfer of structures*

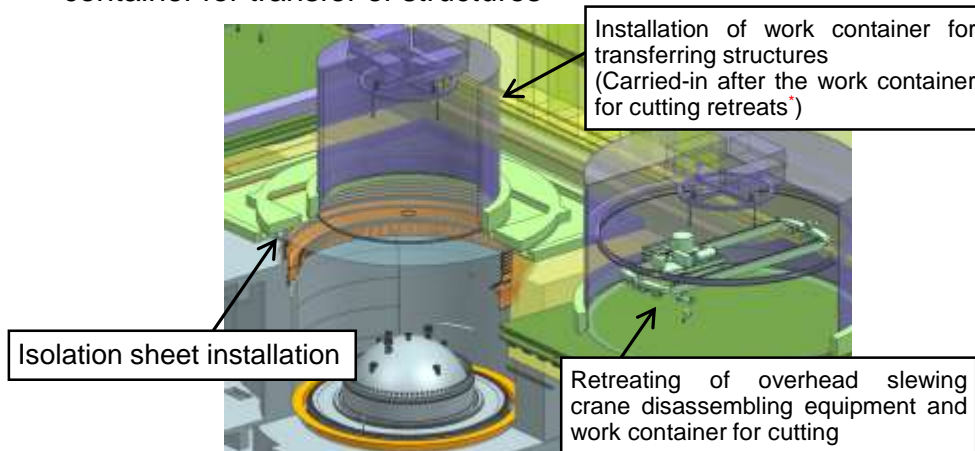

4. Transferring the RPV head

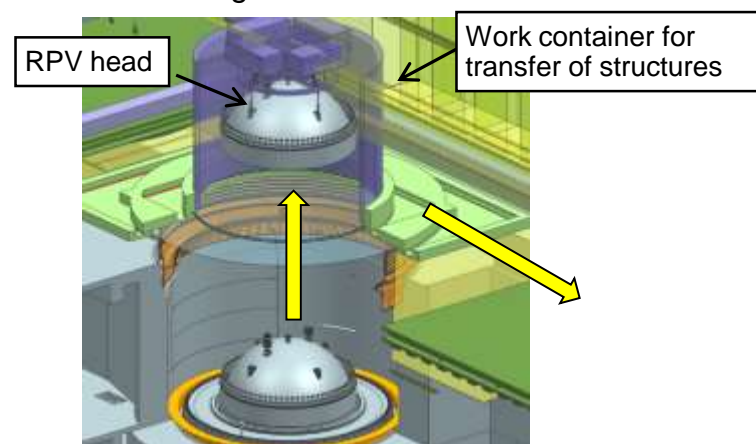

6. Implementation Items of This Project

1) Development of isolation technology to prevent the spread of contamination

[Study of the procedures for confinement of contaminants during retrieval and transportation of large structures]

◆RPV head removal work steps (1/6) *Pre-condition: The work of cutting the RPV head bolt has been completed, and the work container for cutting has retreated.

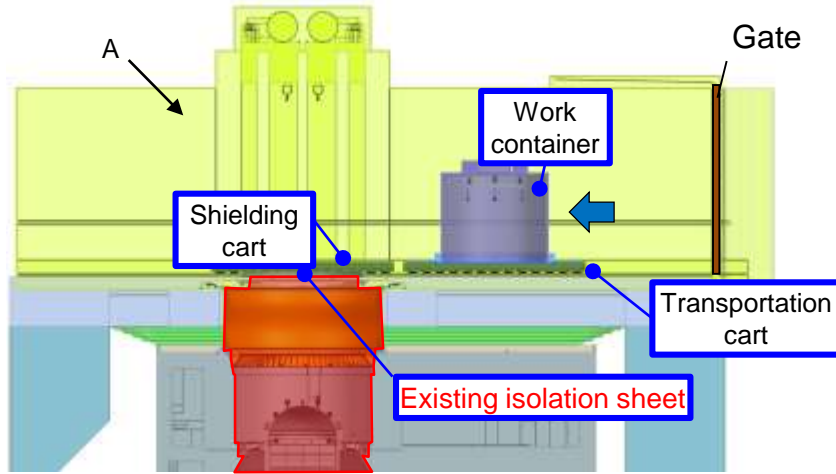

1. Carrying-in work containers for transferring structures

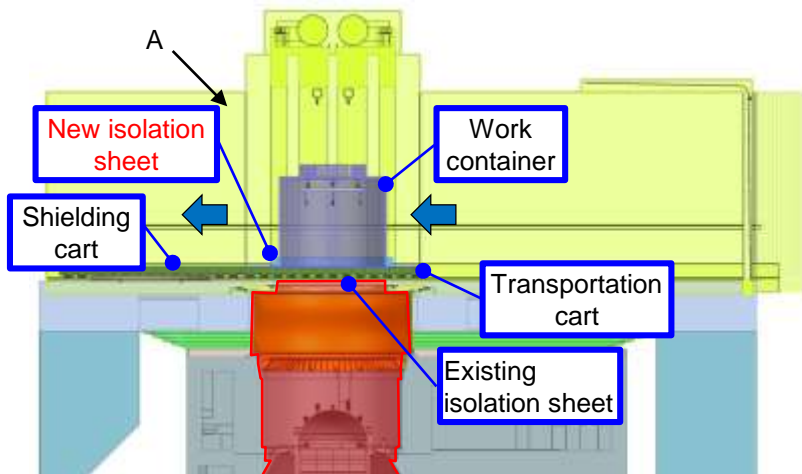

2. Transporting the work containers and moving the shielding cart

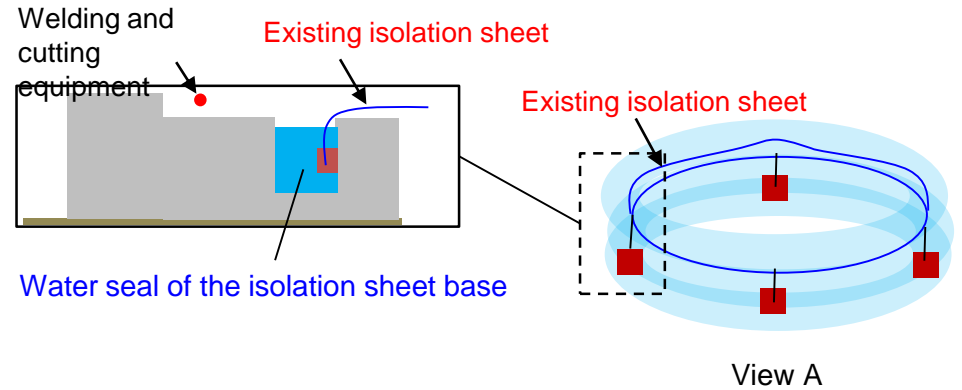

Illustration of the isolation sheet in Step 1

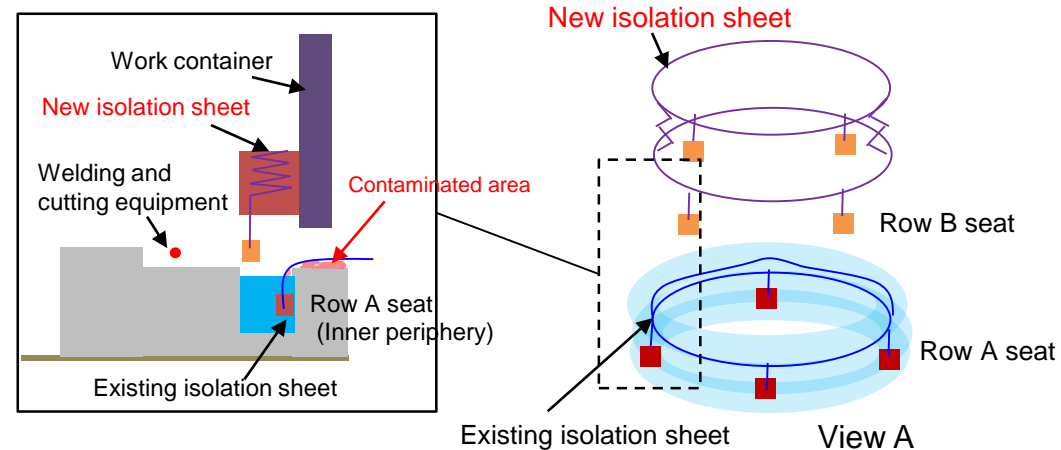

Illustration of the isolation sheet in Step 2

6. Implementation Items of This Project

1) Development of isolation technology to prevent the spread of contamination

[Study of the procedures for confinement of contaminants during retrieval and transportation of large structures]

◆ RPV head removal work steps (2/6)

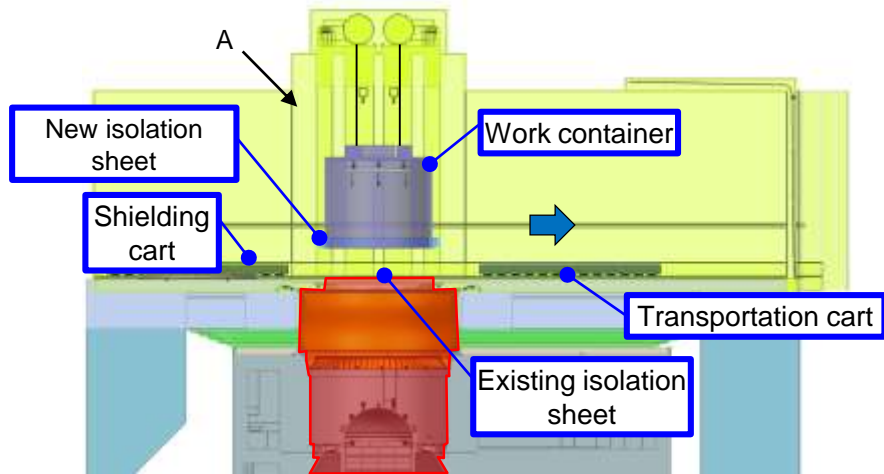

3. Retreating of the transportation cart

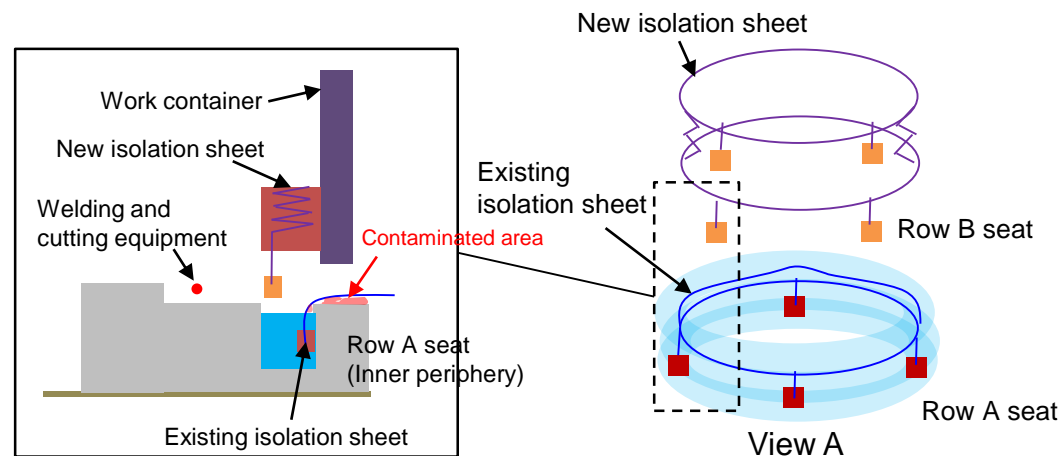
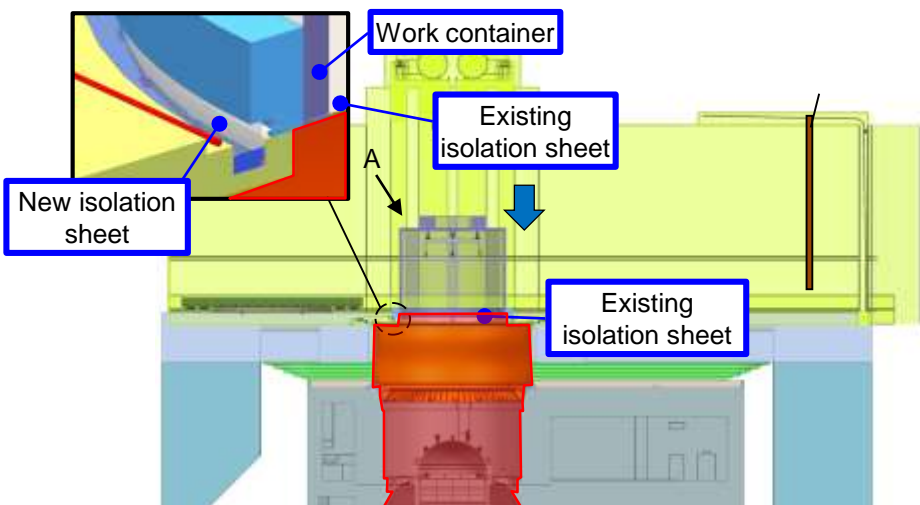
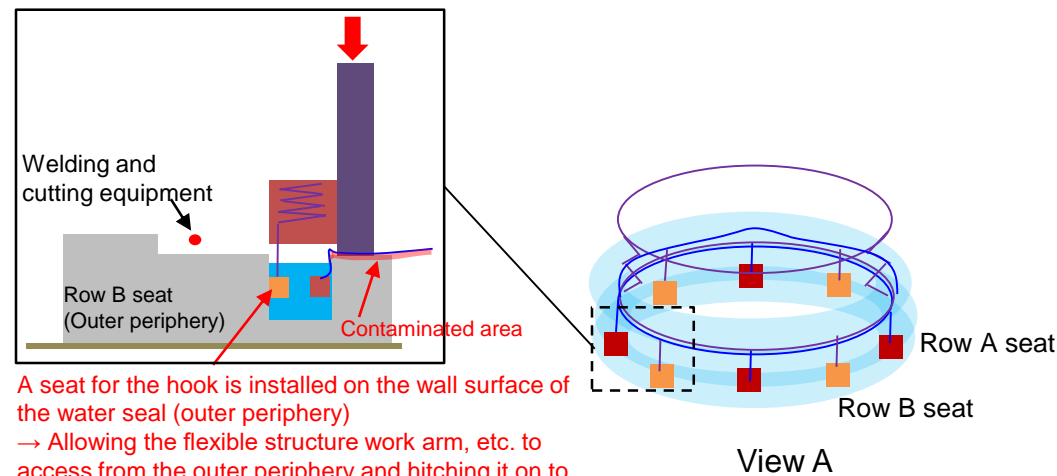

Illustration of the isolation sheet in Step 3



4. Suspending the work container and installing the new isolation sheet



A seat for the hook is installed on the wall surface of the water seal (outer periphery)
 → Allowing the flexible structure work arm, etc. to access from the outer periphery and hitching it on to the row B seat (outer periphery) is being studied.

Illustration of the isolation sheet in Step 4

6. Implementation Items of This Project

1) Development of isolation technology to prevent the spread of contamination

[Study of the procedures for confinement of contaminants during retrieval and transportation of large structures]

◆ RPV head removal work steps (3/6)

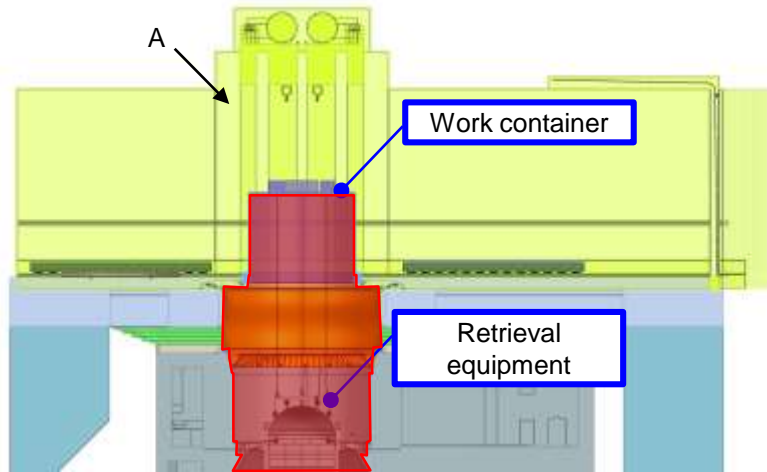

5. Cutting the existing isolation sheet and suspending the retrieval equipment

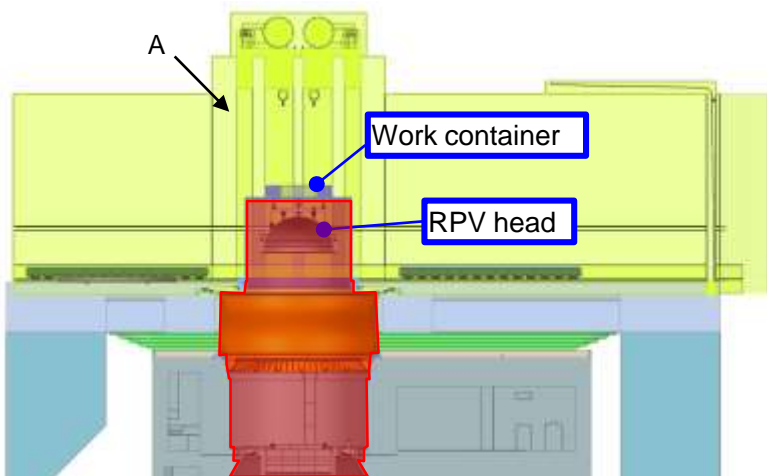

6. Removing the RPV head

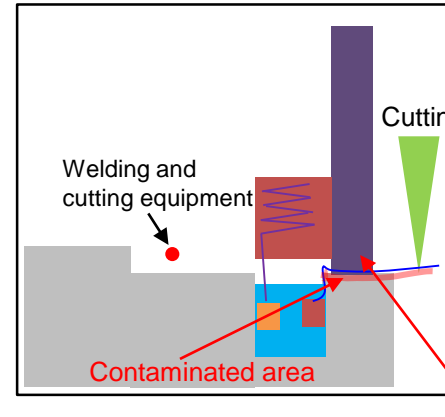

Cutting on the inside of the work container (cutting position, etc. is being studied)

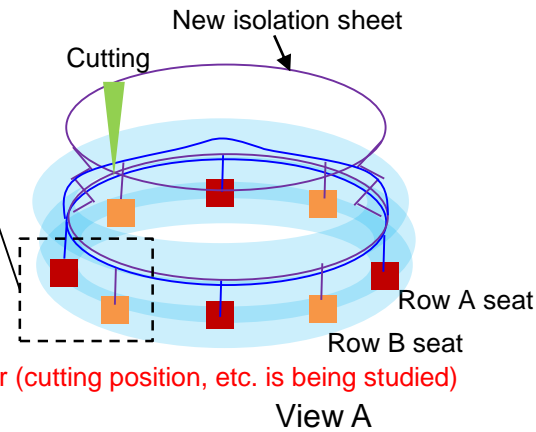
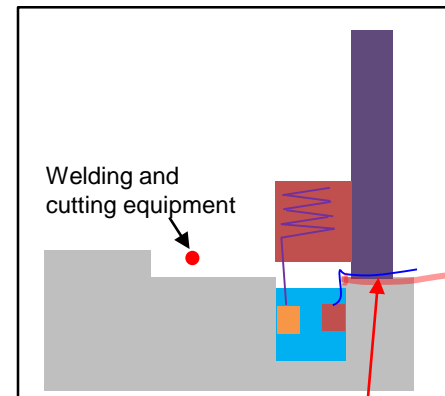

Illustration of the isolation sheet in Step 5



Contaminated area

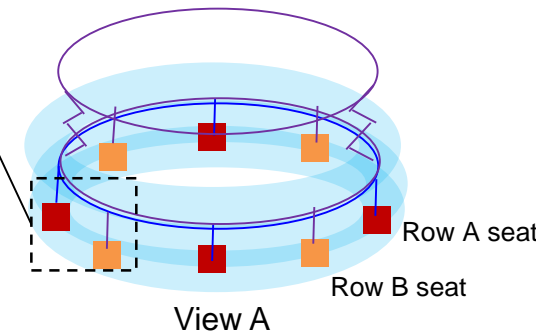
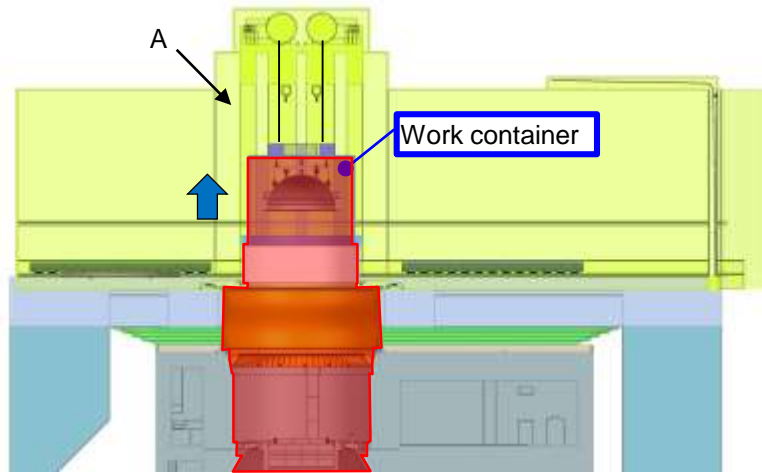

Illustration of the isolation sheet in Step 6

1) Development of isolation technology to prevent the spread of contamination

[Study of the procedures for confinement of contaminants during removal and transportation of large structures]

◆ RPV head removal work steps (4/6)



7. Lifting up the work container

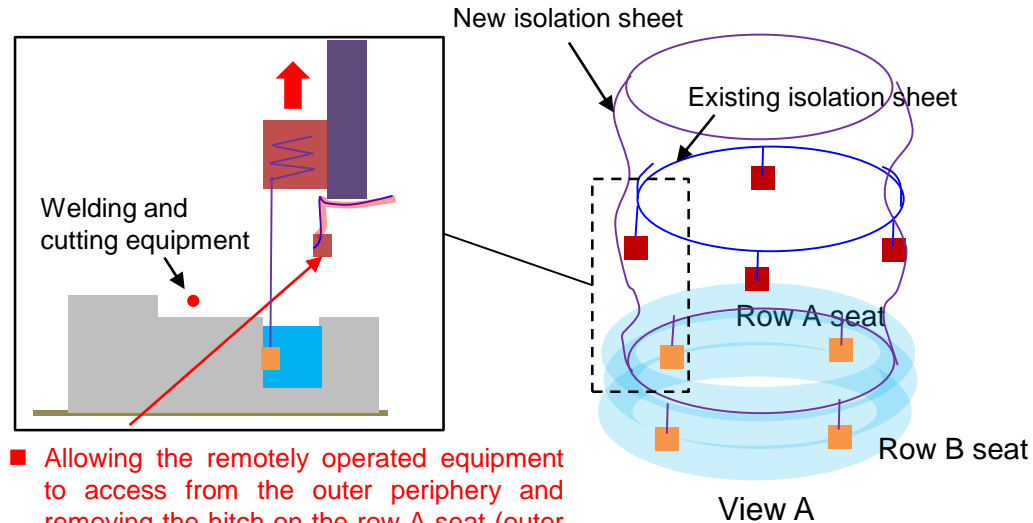

- Allowing the remotely operated equipment to access from the outer periphery and removing the hitch on the row A seat (outer periphery) is being studied.
- The A row seat part is collected by drawing it inside the new isolation sheet.

Illustration of the isolation sheet in Step 7

6. Implementation Items of This Project

1) Development of isolation technology to prevent the spread of contamination

[Study of the procedures for confinement of contaminants during removal and transportation of large structures]

◆ RPV head removal work steps (5/6)

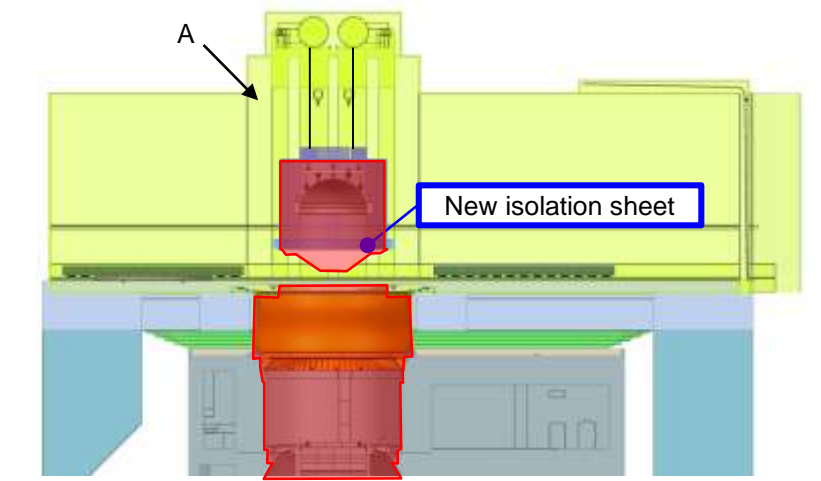

8. Squeezing, welding and cutting the new isolation sheet

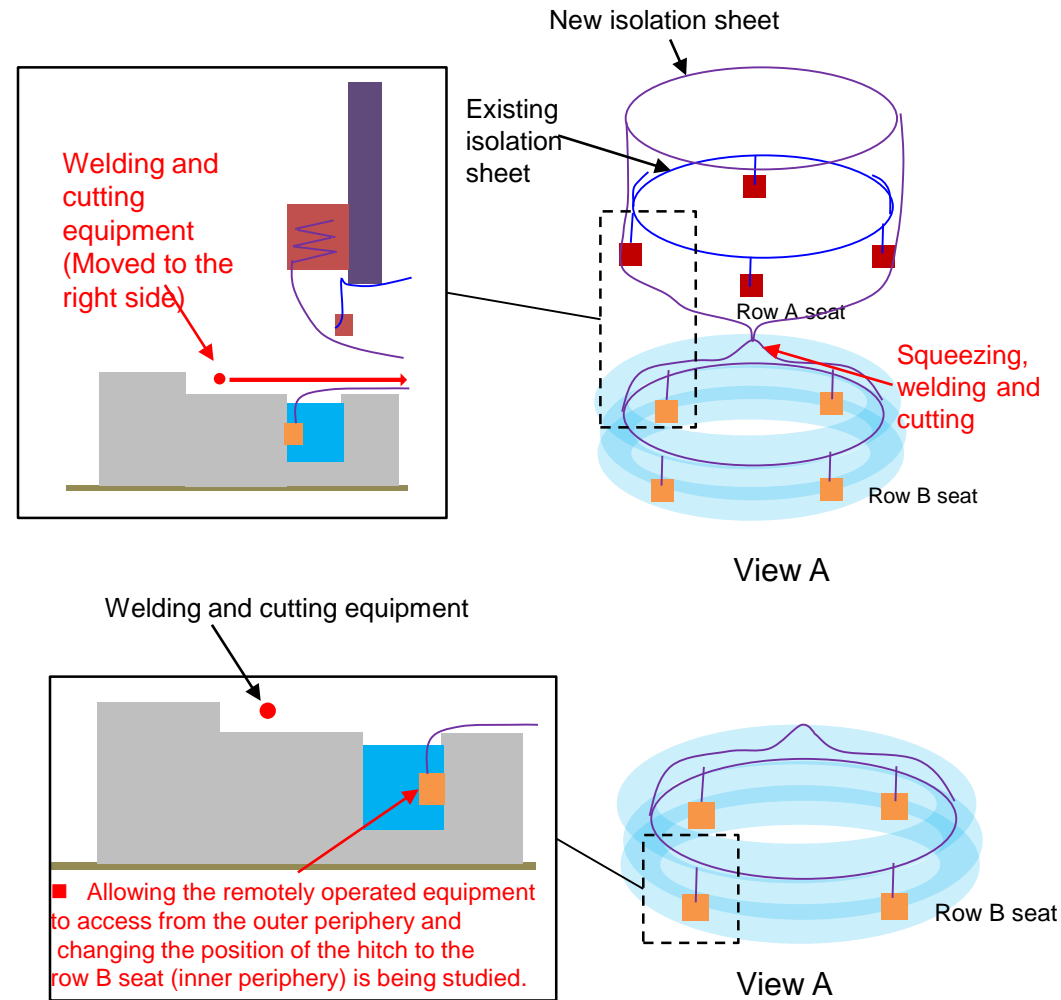

Illustration of the isolation sheet in Step 8

6. Implementation Items of This Project

1) Development of isolation technology to prevent the spread of contamination

[Study of the procedures for confinement of contaminants during removal and transportation of large structures]

◆ RPV head removal work steps (6/6)

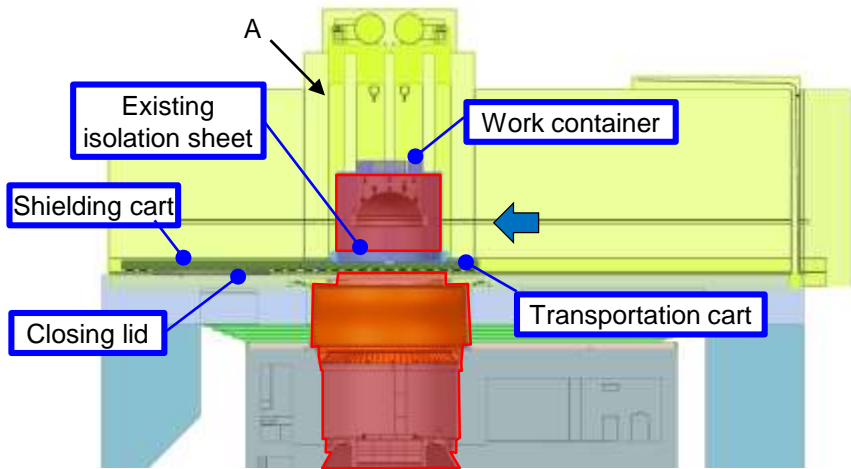

9. Moving the transportation cart, and suspending the work container

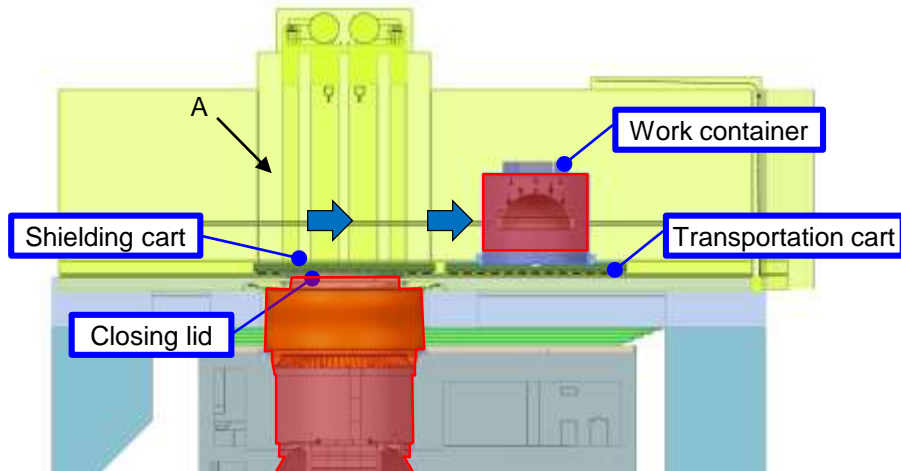

10. Transporting the work containers and moving the shielding cart

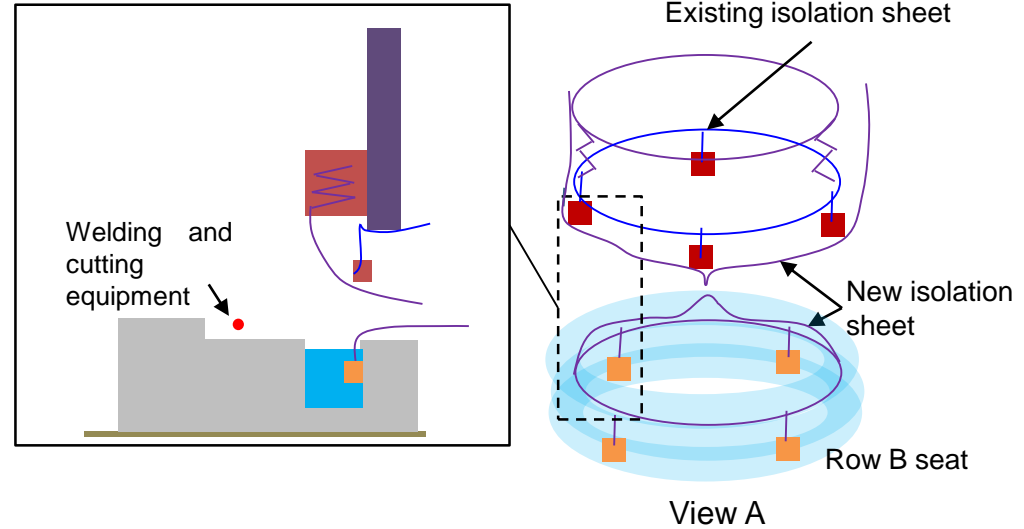

Illustration of the isolation sheet in Step 9

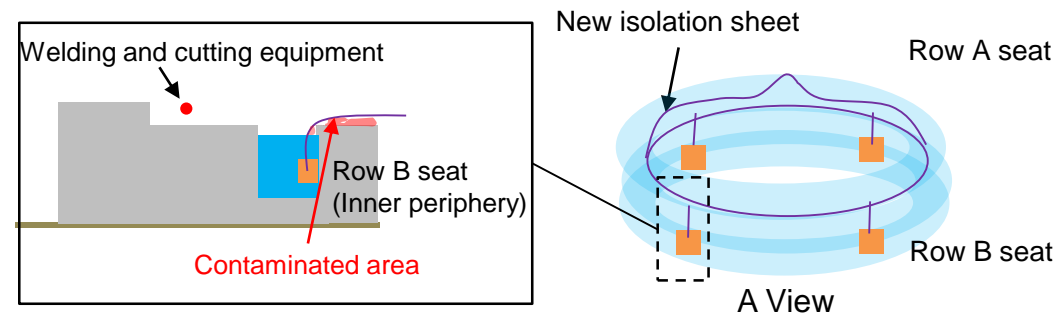

Illustration of the isolation sheet in Step 10

6. Implementation Items of This Project

1) Development of isolation technology to prevent the spread of contamination

[Study of the procedures for confinement of contaminants during removal and transportation of large structures]

◆ Study on handling the isolation sheet (used isolation sheet) after retrieving the structures

The isolation sheet is planned to be used mainly [1] when the structures are retrieved and [2] when the structures are collected in large transfer containers, as shown in the figure below. Handling of used isolation sheets is being studied. The status of the study is indicated below.

[1] When the structures are removed: The cut isolation sheet is placed into the work container along with the structures using the removal equipment.

[2] When the structures are collected: The used isolation sheet mentioned in [1] above, the isolation sheet at the time of collection, and the structures are all placed into the large transfer containers.

→ After being transferred from the additional building, when the structures are removed from the large transfer containers for storage, etc. in other buildings, the isolation sheets are removed as well and are disposed off as waste.

[Notes]
Colors indicate the following contamination levels*
R (Red): Red (high contamination) zone
Y (Yellow): Yellow (moderate contamination) zone
G (Green): Green (low contamination) zone
*Besides color, the main zones are marked as R, Y and G, and the red zone is marked with a red border.

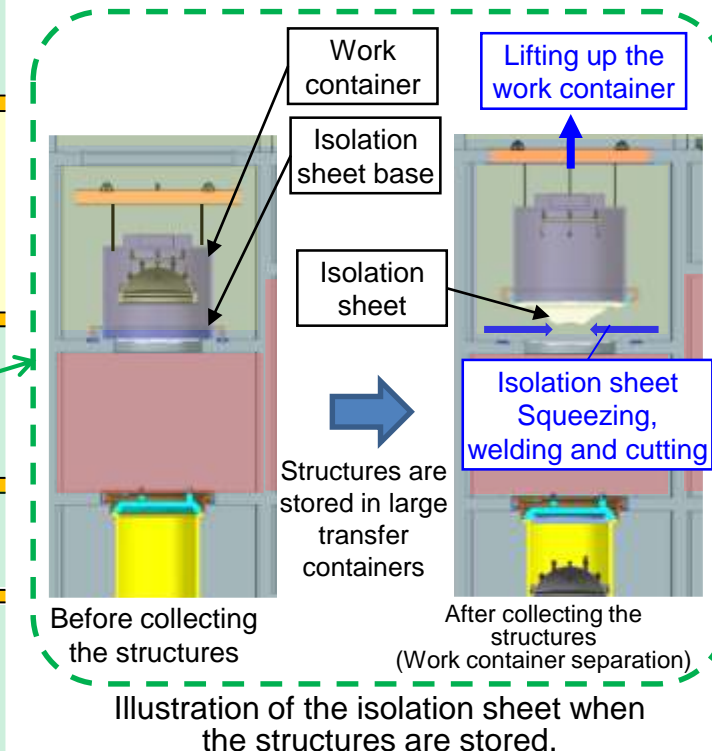
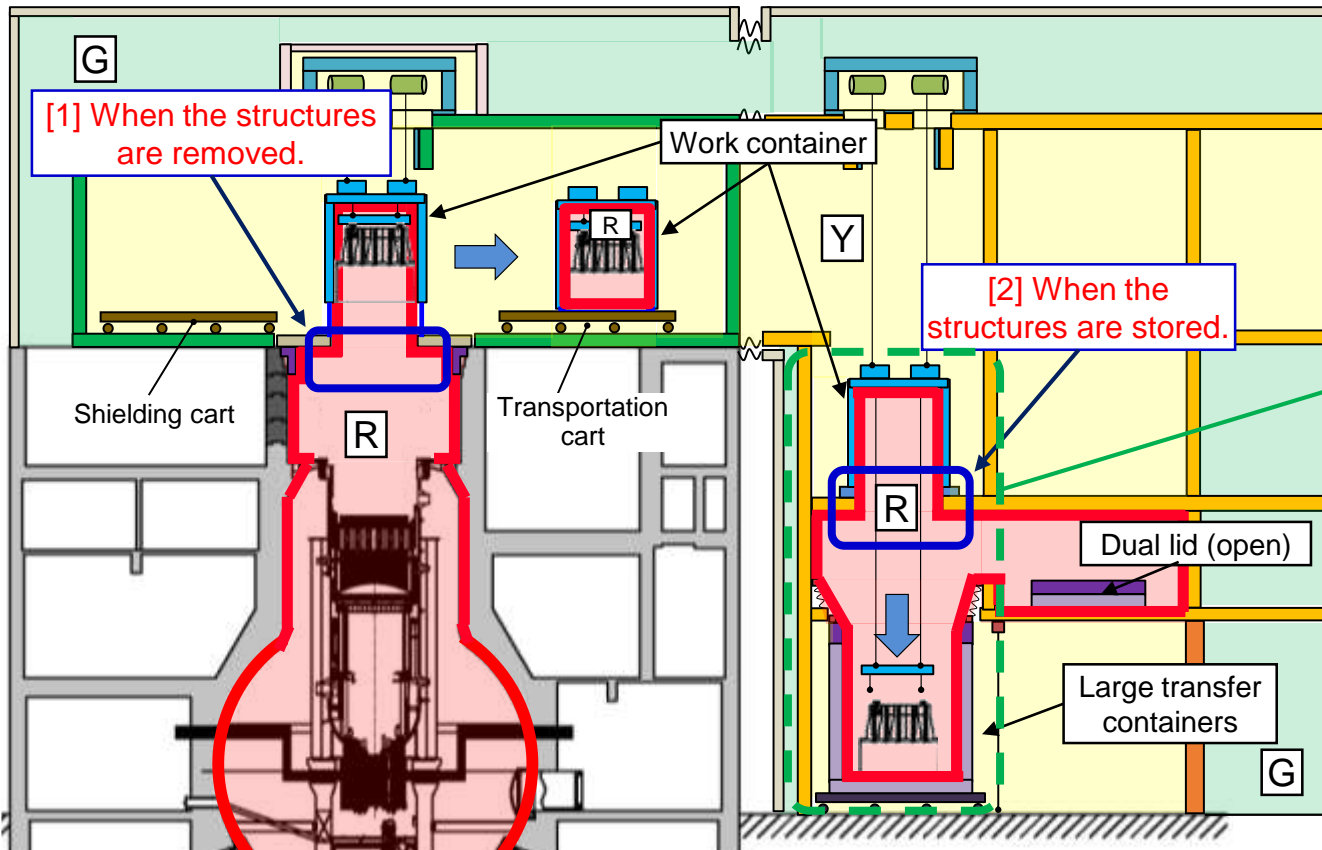

(Note) [1] After retrieving the structures, the new installation sheet (for separation) is installed on the outer periphery of the work container in the additionally built building.

1) Development of isolation technology to prevent the spread of contamination

[Study related to isolation sheets]

The following studies are being conducted under this project

[1] Study of the isolation sheet handling step

(All the steps are being studied under the Project of Development of Fuel Debris Retrieval Method)

→ Steps involved in the method related to isolation sheets is being studied. (Refer to No. 21 - 37)

The required specifications (strength and efficiency of cutting, etc.) of the isolation sheet are studied based on the steps.

[2] Evaluation of the isolation sheet material and the physical properties, study of isolation sheet

→ As described in No. 21, closing the underside of the work container with a maximum inner diameter of 13m, is being studied.

The material that can be used is being investigated and the required physical properties are being evaluated. Inclusion of fibers of nylon, etc. for improving strength is being considered as well.

[3] Study on welding and cutting methods

→ Along with above-mentioned [2], the methods of welding and cutting isolation sheets are also being studied.

[4] Evaluation using scale models, etc.

→ Based on the results of studies above mentioned in [1], [2], and [3], the feasibility is confirmed by means of elemental tests using scale models, etc. (Proposed test items are indicated on the next page)

[5] Study of isolation sheet remote handling equipment

→ The isolation sheet needs to be handled remotely in actual use.

Based on the results of studies mentioned in [3], equipment for remote handling (welding remotely, etc.) is studied.

1) Development of isolation technology to prevent the spread of contamination

[Elemental tests using simulated test pieces]

◆ Items to be verified through elemental tests (proposed)

No.	Items	Details	Remarks (Proposal on specific verification details)
1	Manufacturing efficiency	<ul style="list-style-type: none"> Manufacturing efficiency will be verified by test-manufacturing isolation sheets. 	<ul style="list-style-type: none"> Whether or not manufacturing the sheets in actual dimensions is possible (if it is difficult to manufacture the large unitized large sheets, smaller sheets can be joined together to get larger sheets), etc.
2	Collection efficiency	<ul style="list-style-type: none"> Method for easy collection when the isolation sheet is installed, will be studied, and verified through tests. 	<ul style="list-style-type: none"> Whether the sheet can be folded to fit the assumed size (folding method, whether the surface with the joint can be folded), etc.
3	Air-tightness	<ul style="list-style-type: none"> The method for converging (squeezing) the isolation sheet and ensuring air-tightness by welding, etc. will be studied, and verified through tests. 	<ul style="list-style-type: none"> Leakage rate, etc.
4	Cutting efficiency	<ul style="list-style-type: none"> The cutting efficiency of the isolation sheet will be verified. 	<ul style="list-style-type: none"> Study of cutting method assuming remote operation, work efficiency, etc.

(Remarks)

- The above items will be verified using scale models, etc. The verification items (target values and criteria, etc.) will be specified in the future.
- This plan may change depending on the progress in designing.

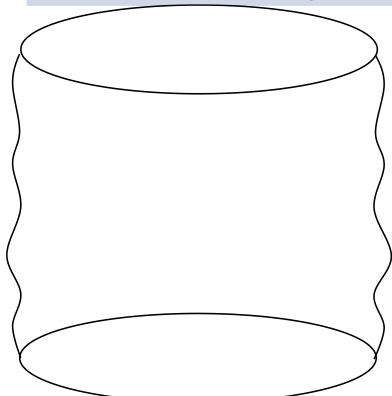

[Illustration of manufacturing efficiency]
 • Study of dimensions considering welding (including excess length after squeezing)

* Dimensions are being studied.

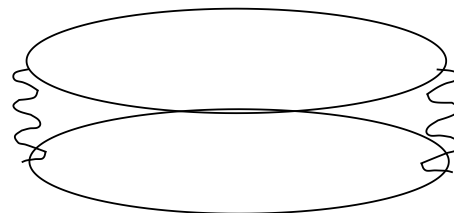

[Illustration of storage efficiency]
 • Study of folding method, required size in the case of storage

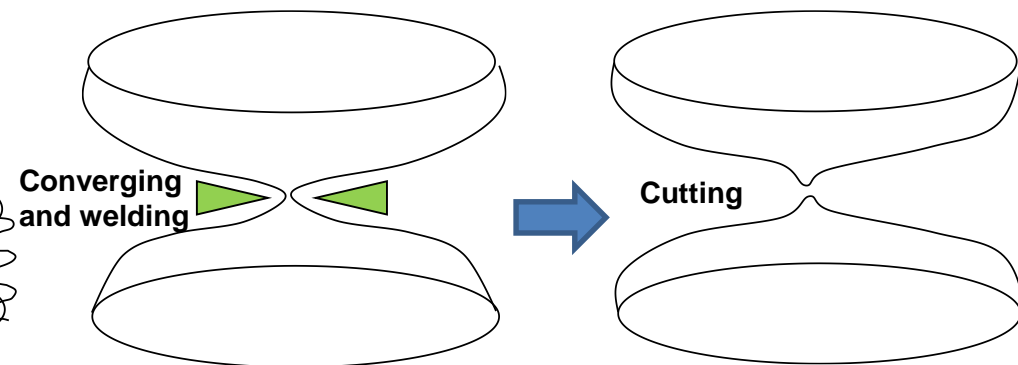

[Illustration of air-tightness (converging and welding) and cutting]
 • Study of converging and welding and cutting methods

1) Development of isolation technology to prevent the spread of contamination

- Technology for confining (isolation mechanism) contaminated material during removal and transportation of large structures is being studied. Isolation mechanisms including opening/closing type, welding type, trap type and shatter-proof type were studied and compared. Then, primary evaluation for the isolation mechanism was conducted, and the welding type (isolation sheet) isolation mechanism was selected based on the aspects of confinement capability and operability.

- The confining procedure using an isolation sheet is being studied. The method for welding/cutting the isolation sheet, procedure for containing the structures into large transfer containers, method for replacing the isolation sheet, etc. are being crystallized.

- Test items and details for verifying the feasibility of the isolation sheet are being studied.

8. Specific Goals for Achieving the Purpose of the Project

<p>1) Development of isolation technology to prevent the spread of contamination</p>	<p>The contaminated material generated from work and the passageways in which it spreads shall be examined, and the contaminated area classification required in the passageways shall be clearly specified. Isolation mechanism (equipment and operating methods, etc.) for preventing the spread of contamination shall be evaluated and selected from the perspective of confinement capability, possibility and operability of remote operations, robustness and durability, inspection/maintainability, etc. and site applicability shall be studied by means of elemental tests. (Target Technology Readiness levels (TRLs) at completion of the project*: Level 3)</p>
--	---

TRL level	Details	Phase
TRL7	Stage at which implementation is complete.	For practical use
TRL6	Stage at which on-site demonstration is conducted.	On-site demonstration
TRL5	Stage at which a prototype is manufactured based on the actual equipment and verified in-factory simulated environment, etc.	Simulated verification
TRL4	Stage at which functional tests are implemented at the test manufacturing level as a development and engineering process.	Research for practical use
TRL3	Stage at which development and engineering are carried out by using applied or combined existing research. Or, stage at which development and engineering are carried out based on fundamental data in fields in which there is no prior experience.	Applied research
TRL2	Stage at which development and engineering are carried out in fields in which there is almost no applicable prior experience, and the required specifications are defined.	Applied research
TRL1	Stage at which specific details pertaining to the development and engineering targets are clarified.	Basic research

*TRL: Technology Readiness Level